

Instructions for use

ASTOFLO[®]

PLUS

eco

Warmer for Blood, Intravenous
Fluids and Irrigation Fluids

REF AFP300

REF AFP302



Part No. 10038.12NA Rev. 06 09/2020

STIHLER ELECTRONIC

STIHLER ELECTRONIC GmbH • 70771 Leinfelden - Echterdingen • Germany

To be filled in by the user:

Serial number

Registration number

Device location

Start-up date

Manufacturer: STIHLER ELECTRONIC GmbH
Gaussstrasse 4
70771 Leinfelden - Echterdingen
GERMANY
Tel. +49 (0) 711-720670
Fax +49 (0) 711-7206757
www.stihlerelectronic.de
E-Mail: info@stihlerelectronic.de

Contents

1 Information about these Instructions	5
2 General information	5
2.1 GUARANTEE CONDITIONS.....	5
2.2 LIABILITY.....	5
2.3 DISPOSAL OF THE EQUIPMENT	6
2.4 RETURN OF A USED PRODUCT	6
2.5 SERVICE INFORMATION	6
3 Important safety information.....	7
3.1 DANGERS	7
3.2 WARNINGS.....	7
3.3 CAUTIONS.....	11
3.4 NOTICES.....	12
4 Specification of application.....	12
4.1 INTENDED USE.....	12
4.2 INTENDED MEDICAL INDICATION	12
4.3 CONTRAINDICATIONS.....	13
4.4 POSSIBLE ADVERSE EFFECTS	13
4.5 INTENDED PATIENT POPULATION	13
4.6 INTENDED USER PROFILE	13
4.7 INTENDED USE/OPERATION ENVIRONMENT	13
4.8 INTENDED PART OF THE BODY/TYPE OF TISSUE.....	13
5 Symbols	14
6 Product description.....	16
6.1 INTRODUCTION	16
6.2 TECHNICAL DESCRIPTION.....	16
6.3 COMPONENTS OF THE ASTOFLO PLUS ECO	19
6.4 CONTROL PANEL.....	21
7 Operating states	23
7.1 STANDBY MODE	23
7.2 ON MODE	24
7.3 HEATING MODE.....	25
7.4 INCREASING/DECREASING THE SET TEMPERATURE OF THE HEATING PROFILE	26
7.5 CHANGING THE BRIGHTNESS OF THE DISPLAY.....	27
8 Installation	28
8.1 INITIAL START-UP	28
8.2 INSTALLATION OF THE WARMER	28
9 Getting started.....	29
9.1 PREPARATION FOR USE	29
9.2 PRIMING, INSERTING THE INFUSION LINE AND STARTING THE INFUSION	31
9.3 AFTER USE.....	33
9.4 CLEANING AND DISINFECTING	34

10 Alarms and troubleshooting	36
10.1 LOW TEMPERATURE ALARM.....	37
10.2 OVERHEATING ALARM.....	38
10.3 CABLE BREAK ALARM.....	39
10.4 SELF-TEST ALARM.....	40
10.5 CONNECTION ALARM.....	41
10.6 STANDBY MODE - FAILURE.....	42
10.7 ON MODE - FAILURE.....	42
11 Brief overview of operating states and alarms	43
11.1 OVERVIEW OF OPERATION STATES.....	43
11.2 OVERVIEW OF ALARMS.....	44
12 Maintenance	45
12.1 RECURRENT TESTS.....	45
12.2 SET UP FOR ELECTRICAL SAFETY TESTS.....	52
12.3 TEST PROTOCOL.....	53
13 Technical data	55
14 Conformity with international standards	56
15 Ordering information and accessories	57
16 Guidelines and manufacturer's declaration	58

1 Information about these Instructions



- **Carefully read the entire instructions for use before using the device.**
- **Correct and safe operation can only be guaranteed if the instructions for use are observed.**
- **Incorrect use can result in damage to the product or to other property and/or personal injury.**
- **Keep the instructions for use for future reference.**
- **Only use the device for the intended purpose as described in these instructions for use. Refer to *chapter 4 Specification of application*.**

2 General information

2.1 Guarantee conditions

The guarantee period is 12 months. During this guarantee period the manufacturer will repair or replace free of charge all defects caused as a result of material or manufacturing errors.

Other damage is not subject to this guarantee. The guarantee does not include cases of misuse or incorrect handling, use of force, or damage caused by normal wear and tear. This applies also to changes undertaken by persons who are not authorised by the manufacturer and to modifications to the original condition.

If the equipment is damaged during the guarantee period, send the cleaned equipment to the nearest sales point or directly to STIHLER ELECTRONIC GmbH. The sender is responsible for any transport and packaging costs.

2.2 Liability

The manufacturer is only liable for the safety, reliability and performance of the equipment

- if all operating, servicing, and calibration procedures have been carried out by trained and qualified persons according to the procedures published by the manufacturer;
- if only original spare parts have been used to replace components as needed;
- if assembly and repairs are only carried out by authorised personnel or an authorised service centre;
- if the electrical installations satisfy the locally applicable regulations and the IEC/EN requirements and
- if the equipment is used for its intended purpose and at a suitable location in accordance with the instructions for use.

2.3 Disposal of the equipment

Electrical devices are recoverable waste and should not be disposed of in domestic waste at the end of their service life. Please follow the local rules for the disposal of used products, or send the cleaned and disinfected equipment with a corresponding note to STIHLER ELECTRONIC GmbH or your closest sales point. This will ensure the most cost efficient and proper disposal of your old equipment.



Follow the national regulations on the disposal of medical products.

2.4 Return of a used product

A report must be sent together with the equipment, detailing the precise reasons, circumstances, and, if known, the cause of the return. To prevent transportation damage, the equipment should be shipped either in the original packaging or in other, well-protected packaging.

WARNING

Risk of infection!

Clean and disinfect the equipment after every use and before you return the equipment for repairs.

NOTICE

The customer is responsible for the proper packaging and labelling of returns.

2.5 Service information

For service or technical support, please contact your local sales point or the following:

STIHLER ELECTRONIC GmbH
Gausstrasse 4
70771 Leinfelden - Echterdingen
GERMANY

Tel. +49 (0) 711-720670
Fax +49 (0) 711-7206757
www.stihlerelectronic.de
E-Mail: info@stihlerelectronic.de

3 Important safety information

These instructions for use define and refer to the following safety information.

DANGER

DANGER indicates a hazardous situation which, if not avoided, will result in death or serious injury.

WARNING

WARNING indicates a hazardous situation which, if not avoided, could result in death or serious injury.

CAUTION

CAUTION indicates a hazardous situation which, if not avoided, could result in minor or moderate injury.

NOTICE

NOTICE indicates a property damage message.

3.1 Dangers

DANGER

Risk of explosion!

Do not use the ASTOFLO PLUS ECO in an environment at risk of explosion or in the presence of flammable anesthetics.

3.2 Warnings

WARNING

Risk of injury!

- Use of the ASTOFLO PLUS ECO must be carried out under the supervision of a physician.
- Read and observe all instructions, stickers, and accompanying documentation enclosed with the medical device. Failure to observe the instructions, including warnings and safety information, can result in incorrect handling, patient injury, injury to users or medical personnel, damage to the device, or material damage.
- Operate and service this equipment only in accordance with the procedures described in these instructions and with the applicable standards, rules, and guidelines. The manufacturer shall not be responsible for the safety of users or patients if any actions/procedures other than those published are carried out during operation, servicing, or recurrent tests.



Risk of injury!

- This device may only be operated by appropriately trained and medically qualified healthcare professionals.
- The service personnel must be appropriately trained and qualified.
- Do not use the ASTOFLO PLUS ECO until the following error conditions have been remedied through appropriate corrective action:
 - Damaged or worn cables, plugs, or connecting socket.
 - Damaged housing, damaged or loose control panel.
 - Control unit has been exposed to mechanical impact / exposed to severe shock or exposed to liquid.
 - Alarm without knowing the cause.
 - Damaged heating profile, e.g. caused by clamps, scissors or improper handling or storage.
 - Damaged or missing markings/safety signs/warnings on the control unit and/or heating profile.
- If the yellow "Alarm" LED and the acoustic alarm signal are not activated automatically when the device turns on by pressing the "Standby" button, remove the device from service immediately.
- In the event of an overheating alarm proceed as outlined below:
 1. Ensure that the ASTOFLO PLUS ECO safety system has deactivated the heating function and that the temperature is dropping below 43°C. If the temperature is not dropping, stop the treatment to prevent fluid from returning to the patient. Remove the applicable tubing immediately from the heating profile. Further evaluation should be carried out by qualified medical personnel such as a physician before blood in the line can be re-infused.
 2. Consider the possible reasons for the alarm. For further information see **chapter 10 Alarms and troubleshooting**. If in doubt, do not continue using the warmer.
- The mains cable should not touch the patient and should not hinder the treating personnel.
- The ASTOFLO PLUS ECO does not contain any parts the user can repair. Therefore, do not attempt to repair the ASTOFLO PLUS ECO yourself. Contact your local sales point.
- Any repairs (such as, but not limited to, changing the power supply cord) to the equipment may only be carried out by persons authorized and qualified by the manufacturer.
- Modifications to the device are not permitted.

**Risk of overheating!**

- Do not insert the blood return line in the wrong flow direction. The flow direction must be from the control unit to the free end of the heating profile.
- The heating profile must hang freely while in use. Do not kink, cover (not even partially), clamp (for example, with a surgical clamp) or roll the heating profile.
- Do not place the heating profile under or directly beside the patient. Heat build-up can occur and/or the infusion line can be squeezed off.
- Do not kink or clamp the heating profile during storage, to avoid internal damage.
- Do not cool or expose to cool temperatures (e.g. by evaporating disinfectants) the area near the temperature sensors (the last 40 cm of the free end of the heating profile).

**Risk of haemolysis!**

Make sure that the infusion line is not kinked.

**Risk of air embolism!**

- When fluids are warmed up, it is possible that gas may evolve (bubbles form).
- Be aware of the potential for air emboli when using a blood and fluid warmer.
- Therefore fully prime all filters, lines and disposable sets before starting a treatment.
- Make sure all connections of the complete fluid stream are fixed tightly to prevent fluid leakages and inadvertent infusion of air into the fluid stream.
- Do not warm infusions containing soluted gas (e.g. bicarbonate).
- Extreme care should always be taken to ensure that a bolus of air does not pass to the patient.

**Risk of infection!**

- Use aseptic procedures.
- Clean and disinfect the warmer after every use and before you return the warmer for repairs.

 **WARNING****Risk of electric shock!**

- To avoid the risk of electric shock, this equipment must only be connected to a supply mains with protective earth.
- Do not use mains adapters that interrupt the earth conductor.
- Do not open the ASTOFLO PLUS ECO housing.
- If several pieces of equipment are combined or connected together (e.g., in multiple socket outlets), the total leakage currents must not exceed the allowable limits (refer to the respective national regulations). Observe the requirements as stipulated in IEC/EN 60601-1 regarding medical electrical systems.
- All electrical installations must conform to the applicable electrical standards and the specifications defined by the manufacturer.
- Before every use, check to make sure that the ASTOFLO PLUS ECO control unit and the heating profile are undamaged.
- The mains plug must be removed from the socket to fully disconnect the ASTOFLO PLUS ECO from the mains.

 **WARNING****Risk of radio interferences!**

- Use of this equipment adjacent to or stacked with other equipment should be avoided because it could result in improper operation. If such use is necessary, this equipment and the other equipment should be observed to verify that they are operating normally.
- Use of accessories, other than those specified or provided by the manufacturer of this equipment could result in increased electromagnetic emissions or decreased electromagnetic immunity of this equipment and result in improper operation.
- Portable RF communications equipment (including peripherals such as antenna cables and external antennas) should be used no closer than 30 cm (12 inches) to any part of the ASTOFLO PLUS ECO, including cables specified by the manufacturer. Otherwise, degradation of the performance of this equipment could result.

3.3 Cautions



Risk of injury!

- Federal law (USA) restricts this device to sale by or on the order of a physician.
- When fixing the warmer to a mounting device, pay attention to the max. load to avoid tilting. Using normal infusion stands ASTOFLO ECO PLUS may be mounted at a height of up to 165 cm. If you use the robust IV pole ASTOSTAND, the device can be mounted up to a height of 2 m.
- Use only approved infusion sets.

Damage to the heating profile can cause overheating, therefore follow the instructions below:

- Only disinfect the heating profile with alcohol-based agents or an approved disinfectant.
- Do not use solutions containing hypochlorite (bleach) for disinfecting the heating profile.
- Do not kink or pull the heating profile excessively.
- Do not use any clamps or sharp instruments on the heating profile as damage to the profile or the infusion line inside may result.
- Use narrow plaster strips or other narrow, soft fixation methods (for example cannula fixation, tube holder or Velcro®) to fix the heating profile.
- Do not use cleaning and disinfection procedures which differ from the procedure described.



Risk of hypothermia!

- When ASTOFLO PLUS ECO is used, the patient's body temperature must be monitored at regular intervals.
- The specified heating performance will only be achieved by inserting the infusion line into the entire length of the heating profile.
- The temperature control of the ASTOFLO PLUS ECO controls and monitors the temperature of the heating profile, but not the patient's body temperature.
- If the ASTOFLO PLUS ECO cannot be started or if the patient's temperature balance is insufficient, consider the use of alternative warming methods in order to avoid or reduce hypothermia or to improve the patient's well-being.

CAUTION

Risk of needle dislodgement!

The weight of the heating profile pulls on the patient's infusion line. Carefully secure the patient's access against pulling. Attach the heating profile by suitable methods (e.g. tape, plaster or Velcro®).

CAUTION

Risk of radio interferences!

- The essential performance can be lost or degraded due to EM disturbances. As a result, there is the possibility of hypothermia of the patient.
- According the standard IEC/EN 60601-1-2, medical electrical equipment requires special precautions regarding electromagnetic compatibility (EMC) and needs to be installed and put into service according the EMC information provided.
- The device/system can cause radio interferences or can interfere with the operation of devices in the vicinity. Appropriate measures may be necessary, such as reorienting or relocating of ASTOFLO PLUS ECO or shielding.

3.4 Notices

NOTICE

- To avoid damage to the warmer:
 - Do not immerse the control unit or the heating profile in liquid.
 - Do not disinfect the warmer with these methods:
 - steam (autoclave)
 - hot air
 - thermo-chemical cleaning solutions.
 - Refer to the specific instructions for use of the disinfectants.
- To avoid damaging during storage, place the heating profile loosely around the control unit and do not kink or clamp it. Use narrow plaster strips or other narrow, soft fixation methods (for example cannula fixation, tube holder or Velcro®) to fix the heating profile.
- The customer is responsible for the proper packaging and labelling of returns.

4 Specification of application

4.1 Intended use

ASTOFLO PLUS ECO is a warmer for warming transfusions, infusions, fluids and for warming blood transfusions and return blood flow.

4.2 Intended medical indication

The warming of medical fluids with ASTOFLO PLUS ECO supports the prevention and therapy of hypothermia.

4.3 Contraindications

There are no known contraindications for warming blood, intravenous fluids and irrigation fluids.

4.4 Possible adverse effects

When the ASTOFLO PLUS ECO is used as a warmer for return blood flow in a haemofiltration, haemodialysis or haemodiafiltration device, it must be ensured that the entire system meets the following:

- The highest set temperature (43°C) must be used with care when operating at low effluent flow rates (below 500 ml/h) for patients who weigh less than 30 kg. Global positive heat balance and net patient warming may occur. If necessary, operate the warmer at a reduced temperature setting.
- Do not allow the heating profile or the power supply cord to interfere with the scales, fluid bags or scale hooks.

4.5 Intended patient population

There are no restrictions for the intended patient group.

4.6 Intended user profile

The ASTOFLO PLUS ECO Warmer is to be operated only by medically qualified and trained healthcare professionals.







4.7 Intended use/operation environment

- The warmer may only be used in professional healthcare facilities (e.g. hospital, emergency care, dialysis, including HF surgical equipment, etc.).
- The warmer is not intended for home healthcare environment.
- The warmer is reusable, but requires cleaning / disinfection between the applications.
- Appropriate medical hygienic factors must be applied for the use of the warmer.
- The warmer must not be used in an environment at risk of explosion or in the present of flammable anesthetics.











4.8 Intended part of the body/type of tissue

















The warmer is used to warm blood or other medical fluids supplied to the body. The fluids are physically separated from the warmer by disposable parts (tubes). During application the heating profile has skin contact.

5 Symbols

Symbols, used on the Control Panel	
	Alarm condition if the yellow LED is on
	"Standby" button: Changes between Standby Mode and On Mode . The warmer is in Standby Mode if the blue LED is on.
	"Start" button: Switches to the Heating Mode . The warmer is in Heating Mode if the green LED is on.
 SET	"Set" button: Changes the set temperature of the heating profile in 1.0° C increments.
	If the "Set" button" and "Test" button is pressed at the same time the brightness of the display is changed (three steps).
	"Test" button: Starts safety tests
	Temperature setting range is limited

Where applicable, these symbols appear at the appropriate location on the warmer, on the packaging, on the identification plate, or in the accompanying documentation.

	Defibrillation-proof type CF applied part in accordance with IEC/EN 60601-1
IPX 1	Protected from drips under the specified operating conditions in accordance to IEC 60529.
 	Refer to instructions for use! / Follow instructions for use!
 only	Caution: Federal US law restricts this device to sale by or on order of a physician.
 	General warning sign
	Catalogue number
	Serial number
	Year of manufacture
	Manufacturer
	Prohibition: Do not cover heating profile – risk of overheating!

	Prohibition: Do not clamp the heating profile – risk of damage and possible overheating!
	Prohibition: Do not disinfect the heating profile with Hypochlorite solution – risk of damage and possible overheating!
	Pay attention to the flow direction of the fluid to the patient - risk of fluid overheating!
	Symbol at the connector for potential equalization according IEC/EN 60601-1.
	Electrical devices are valuable products and should not be thrown in dustbin when they reach the end of their serviceable life.
	MEDICAL – GENERAL MEDICAL EQUIPMENT AS TO ELECTRICAL SHOCK, FIRE AND MECHANICAL HAZARDS ONLY IN ACCORDANCE WITH standards ANSI/AAMI ES60601-1:2005/(R)2012 and A1:2012), C1:2009/(R)2012 and A2:2010/(R):2012 CAN/CSA-C22.2 No. 60601-1:2014. Control No. 75JA
	This symbol indicates additional information.
	Indicates the temperature range within which the package must be stored and handled.
	Indicates the ambient humidity range within which the package must be stored and handled.
	Indicates the pressure range within which the package must be stored and handled.
	Indicates the upright position of the package.
	The package must be kept in a dry environment.
	The contents of the package are fragile and must therefore be handled with care. Do not drop or throw.
	Recyclable - Polystyrene (acc. GB 18455-2001)
	Recyclable - Cardboard (acc. GB 18455-2001)
	Acoustic alarm signal
	No acoustic alarm signal

6 Product description

6.1 Introduction

ASTOFLO ECO PLUS consists of a control unit and a heating profile.

ASTOFLO ECO PLUS is a device for specific heating of blood and fluids which are delivered to the patients by transfusion, infusion or irrigation. The warming of the liquid supports the prevention and therapy of hypothermia during or after surgery; during longer procedures such as dialysis, hemofiltration, or apheresis the warming leads to a well-being. The applications of the ASTOFLO PLUS ECO therefore include transfusion, infusion, dialysis, hemofiltration and apheresis.

The ASTOFLO PLUS ECO Warmer can be used to warm fluids administered to a patient at low flow rates (0 to 2000 ml/h, i.e. 0 to 30 ml/min), see figures 1 to 3. Even at very high flow rates ASTOFLO PLUS ECO keeps pre-heated infusions and fluids to the patient warm.

The heating profile is considered as "applied part" (IEC/EN 60601-1).

6.2 Technical description

During operation of the Warmer heat is transferred from the internal heating wire to the heating profile. Commercially available infusion sets can simply be inserted in the flexible groove of the heating profile. The heat from the heating profile is transferred through the infusion sets to the fluid to be warmed.

The temperature of the heating profile is monitored by a microprocessor controlled temperature control system and by independent alarm systems designed to alert the operator to failure conditions and, if necessary, to switch off the heating process automatically in the event of excessively high temperatures.

During operation, the control panel shows the internal temperature of the heating profile; this is not equal to the temperature of the medium to be warmed. The ASTOFLO PLUS ECO neither regulates nor monitors the current temperature of the medium to be warmed. The temperature of the medium to be warmed depends on a variety of factors, such as, but not limited to additional factors:

- room temperature and ventilation
- inlet temperature of the fluid (warmed-up or cold)
- flow rate
- material of the infusion set (PVC, EVA, PU)

⚠ CAUTION**Risk of hypothermia!**

- When ASTOFLO PLUS ECO is used, the patient's body temperature must be monitored at regular intervals.
- The specified heating performance will only be achieved by inserting the infusion line into the entire length of the heating profile.
- The temperature control of the ASTOFLO PLUS ECO controls and monitors the temperature of the heating profile, but not the patient's body temperature.
- If the ASTOFLO PLUS ECO cannot be started or if the patient's temperature balance is insufficient, consider the use of alternative warming methods in order to avoid or reduce hypothermia or to improve the patient's well-being.

Typical temperature curves are shown in the following figures.

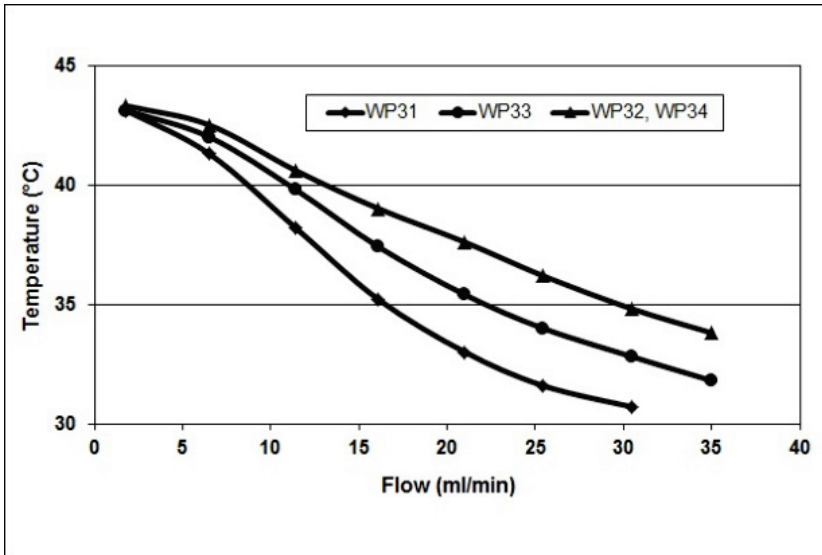

Fig. 1 Typical outlet fluid temperatures at 20°C inlet temperature, set temperature 43°C, PVC

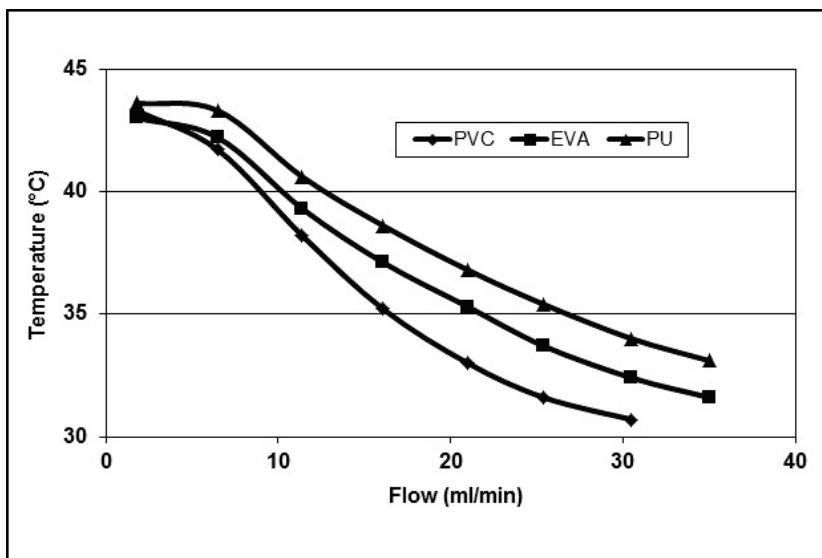

Fig. 2 WP31 outlet fluid temperatures at 20°C inlet temperature, set temperature 43°C and different infusion sets.

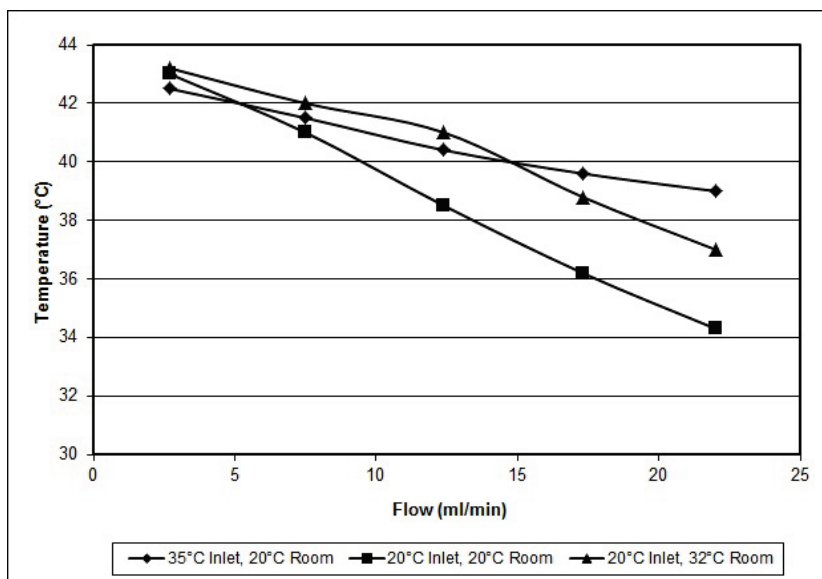

Fig. 3 WP31 outlet fluid temperature at Set temperature 43°C, different room and inlet temperatures

6.3 Components of the ASTOFLO PLUS ECO

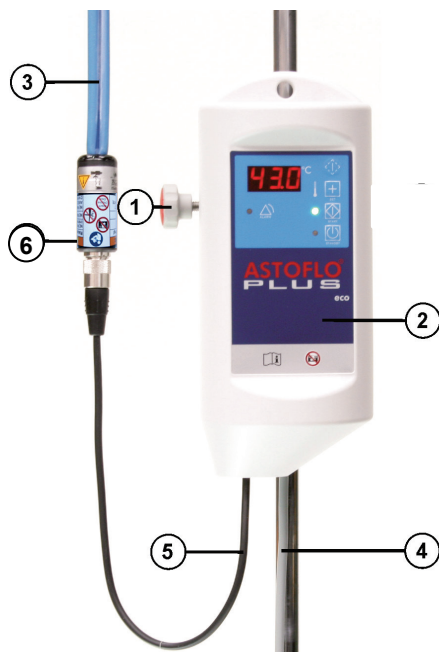

Fig. 4 ASTOFLO PLUS ECO front

#	Part	Description
1	Screw with Star Grip	For adapting the attachment device to infusion stands of different diameters.
2	Control Panel	Offers control buttons and indicators (chapter 6.4 Control panel).
3	Flexible Heating Profile changeable	Transfers heat from the internal heating wire to the medium to be warmed via the inserted infusion line.
4	Power Supply Cord with Mains Plug	Conveys electricity from the wall power outlet to the control unit. Pull the mains plug to disconnect from supply network.
5	Connection Cable Heating Profile	Connects the control unit and changeable heating profile.
6	Adaptor of Heating Profile	Connects the heating profile and cable.

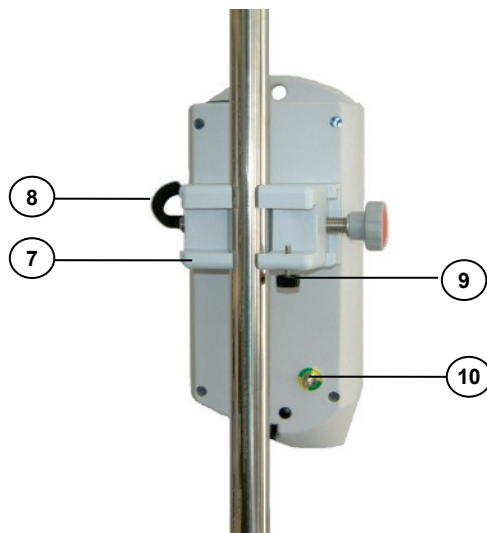

Fig. 5 ASTOFLO PLUS ECO back

#	Part	Description
7	Universal Attachment Device	For secure attachment of the control unit.
8	Clip for Heating Profile	Fixes the heating profile/infusion line.
9	Knurled screw	Protects the device against accidental detaching from the medical rail.
10	Connector for Potential Equalization	<p>The purpose of additional potential equalization is to equalize potentials between different metal parts that can be touched simultaneously, or to reduce differences of potential which can occur during operation between the body, the medical electrical devices and conductive parts of other objects.</p> <p>The connection is made by green-yellow insulated leads (min. 4 mm²) to standardized plug connectors and receptacles.</p> <p>When connecting/combining medical electrical equipment together to a medical electrical system, the requirements of IEC/EN 60601-1 must be observed.</p>

6.4 Control panel

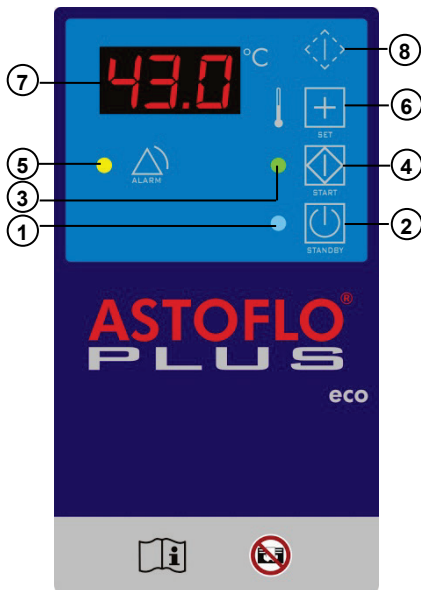

Fig. 6 Control panel



#	Item	Description
1	“Standby” LED	Illuminates when the device is in Standby Mode .
2	“Standby” button	Press to switch from any Mode to Standby Mode . Press to switch from Standby Mode to On Mode . In this case: <ul style="list-style-type: none"> • All segments of the display (7) and all LEDs flash and the acoustic alarm beeps once to confirm that the control unit works properly. • Set temperature is flashing for about 3 seconds. • Current temperature of the heating profile is displayed • “Start” LED (3) flashes.
3	“Start” LED	Flashes when the device is in On Mode (not yet heating). Illuminates when the device is in Heating Mode (“Start” button (4) is pressed).
4	“Start” button	Press to start heating process, when the device is in On Mode or Alarm Mode . Press to start the test when the device is in Test Mode .





#	Item	Description
5	“Alarm” LED	Turns on and the acoustic alarm beeps automatically if an alarm condition exists.
6	“Set” button	Press briefly to indicate the actual set temperature. Press several more times to select a set temperature when the device is in On Mode or in Heating Mode .
		Press to select a particular test when the device is in Test Mode .
		Press to select the brightness of the display ⑦ after pressing “Test” button ⑧ and “Set” button ⑥ together.
7	Display	Informs the user about temperatures, test and fault conditions.
8	“Test” button	Press to switch to Temperature Sensors Test when the device is in On Mode .
		Press to switch to Test Mode when the device is in Heating Mode .

The following section provides further information about the operating states. This includes a description of the actions of the user and the device responses of each operating state.

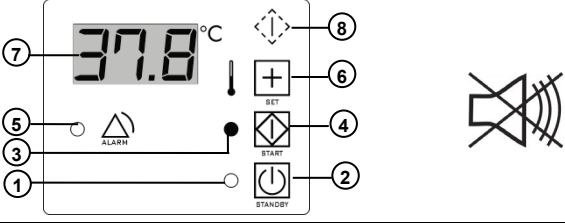

7 Operating states



7.1 Standby mode	
Control panel	
Action	<p>When the mains cable is plugged into the socket, the device is in Standby Mode.</p> <p>Alternately, press the “Standby” button ② to switch the device from any Mode to Standby Mode.</p>
Device response	<ul style="list-style-type: none"> • The display ⑦ turns off. • The “Start” LED ③ turns off. • The “Alarm” LED ⑤ turns off. • The “Standby” LED ① turns on when the device is switched to Standby Mode.
	<ul style="list-style-type: none"> • After power failure the device automatically switches to Standby Mode. • In Standby Mode only the electronics and the heating profile are disconnected from the power supply. The control unit remains connected to the mains.

7.2 On mode	
Control panel	
Action	Press the “Standby” button ② to switch the device from Standby Mode to On Mode.
Device response	<ul style="list-style-type: none"> • The “Standby” LED ① turns off. • The device performs a self-test. All segments of the display ⑦ and all LEDs flash and the acoustic alarm signal beeps once to indicate that the control unit is functioning correctly. • The “Start” LED ③ flashes and the display ⑦ indicates the set temperature flashing for approximately 3 seconds. • After that the current temperature of the heating profile (e.g. 25.1°C) is displayed. • If the current temperature is below 18°C the display ⑦ indicates  • If the current temperature is above 48°C the display ⑦ indicates 

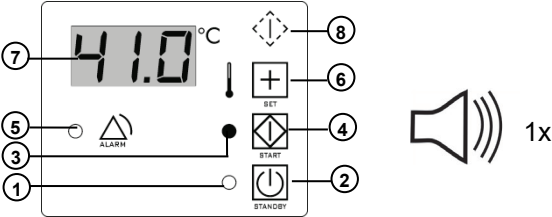
7.3 Heating mode	
Control panel	
Action	<p>Press the “Start” button (4) to switch the device from On Mode to Heating Mode to start the heating of the heating profile.</p>
Device response	<ul style="list-style-type: none"> • “Start LED” (3) turns on. • A self-test is performed. During this test the excessive temperature and cable break alarms are activated once to check the function of the cut offs. • The temperature regulation is activated. • The display (7) shows the current temperature (e.g. 37.8 °C) of the heating profile. • If the current temperature is below 18°C the display (7) indicates  • If the current temperature is above 48°C the display (7) indicates 
	<ul style="list-style-type: none"> • The device can be started 3 seconds after the mains plug is connected to the socket. • By pressing the “Start” button (4) too soon, the selftest alarm can be triggered (the display indicates „E“). In this case switch the warmer off and on using the “Standby” button (2) and repeat the procedure.

7.4 Increasing/Decreasing the set temperature of the heating profile

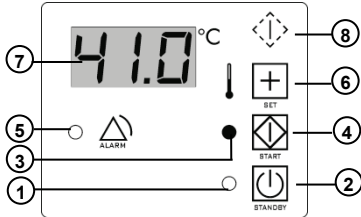
Control panel	
Action	<ol style="list-style-type: none"> 1. Press the “Set” button ⑥ while the control unit is turned on (On Mode) or started (Heating Mode). 2. While the display is flashing, you can select any set temperature between 33.0°C and 43.0°C in 1°C increments by repeatedly pressing the “Set” button ⑥. When the set temperature reaches 43.0°C, the next press of the “Set” button ⑥ returns to 33.0°C.
Device response	<ul style="list-style-type: none"> • The set temperature is displayed and flashes for approximately 3 seconds (e.g. 41.0°C). • After the selection has been made the display ⑦ will continue to flash this set temperature for approximately 3 seconds then revert to current temperature. • After changing the set temperature the acoustic alarm beeps once to confirm the new set temperature. • When the control unit is in Heating Mode, temperature regulation is activated with the new set temperature. • The set temperature most recently used is retained in memory even after power is turned off.
	<ul style="list-style-type: none"> • The set temperature can be checked at any time by pressing the “Set” button ⑥. • During operation, the control panel shows the internal temperature of the heating profile; this is <u>not equal</u> to the temperature of the medium to be warmed. The ASTOFLO PLUS ECO neither regulates nor monitors the current temperature of the medium to be warmed.

7.5 Changing the brightness of the display	
Control panel	
Action	<p>1. Press the “Test” button ⑧ and “Set” button ⑥ shortly at the same time while the control unit is turned on (On Mode) or started (Heating Mode).</p> <p>The display ⑦ indicates</p>  <p>2. Then press the “Set” button ⑥ within 2 seconds once or several times to select the brightness of the display ⑦.</p>
Device response	<ul style="list-style-type: none"> • The brightness of the display ⑦ is changed. • It can be selected between low, middle and high brightness. • After changing the brightness of the display ⑦ shows again the current temperature of the heating profile.

8 Installation

8.1 Initial start-up

Prior to first use, perform the following inspections:

- Visual inspection (**chapter 12.1 Recurrent tests**).
- Check the mains voltage (compare the details on the type label with the available mains voltage.) An incorrect mains voltage may destroy the equipment.

National regulations may require different inspections for the initial start-up. If additional tests are required for electrical safety, these must be carried out according to **chapter 12.1 Recurrent tests**, **12.2 Set up for electrical safety tests** and **12.3 Test protocol**.

8.2 Installation of the warmer

For safe installation, the warmer is equipped with a universal attachment device. With this, the device can be securely attached to infusion stands as well as to medical standard rails.

8.2.1 Attachment to infusion stands/rods

1. Turn the hand wheel counterclockwise to open the attachment device.
2. Select a maximum height of 165 cm (ASTOSTAND: 180 cm) at the infusion stand and place the open clamping area of the attachment device on the infusion stand.
3. Turn the hand wheel clockwise to lock the attachment device to the infusion stand.
4. Check that the warmer is firmly fixed.

8.2.2 Attachment to medical rails

1. Unscrew the small knurled screw on the bottom of the attachment device.
2. Hang the warmer obliquely from above with the attachment device into the standard rail.
3. Fix the heater by tightening the small knurled screw to the standard rail.
4. Check that the warmer is firmly fixed.

9 Getting started

Getting started is grouped into 4 sections. Read through each section before performing a procedure.



- To achieve the greatest possible benefit the ASTOFLO PLUS ECO should be set up close enough to the patient for the end of the flexible heating profile to reach the point of injection.
- The ASTOFLO PLUS ECO should be switched to **Heating Mode** before use so that the heating profile can heat up. The heating-up process takes about 4 minutes at 20°C room temperature.
- Do not position the device in a manner that is difficult to disconnect it from mains by the mains plug.

9.1 Preparation for use

WARNING

Risk of injury!

- In the event that any of the following has occurred, do not use the ASTOFLO PLUS ECO until the appropriate corrective measures have been taken:
 - Damaged or worn cables, plugs, or connecting socket.
 - Damaged housing, damaged or loose control panel.
 - Control unit has been exposed to mechanical impact / exposed to severe shock or exposed to liquid.
 - Alarm without knowing the cause.
 - Damaged heating profile, e.g. caused by clamps, scissors or improper handling or storage.
 - Damaged or missing markings/safety signs/warnings on the control unit and/or heating profile.
- Use of the ASTOFLO PLUS ECO must be carried out under the supervision of a physician.
- The mains cable should not touch the patient and should not hinder the treating personnel.

CAUTION

Risk of injury!

When fixing the Warmer to a mounting device, pay attention to the max. load to avoid tilting. Using normal infusion stands ASTOFLO ECO PLUS may be mounted at a height of up to 165 cm. If you use the robust IV pole ASTOSTAND, the device can be mounted at a height of 2 m.

1. Attach the control unit to infusion stand or to a medical standard rail using the attachment device according to **chapter 8.2 Installation of the warmer**.
2. Plug the mains plug of the control unit into a socket ("Standby" LED turns on to show that the control unit is in **Standby Mode**).







Fig. 7 Connecting heating profile

3. Connect the heating profile to the control unit according Fig. 7.
4. Press the "Standby" button  to switch the warmer to **On Mode**.

WARNING

Risk of injury!

If the yellow "Alarm" LED and the acoustic alarm are not activated automatically when the device turns on by pressing the "Standby" button, remove the device from service immediately.

5. Check the acoustic and visual signals and the display:
 - All segments of the display and all LEDs flash and the acoustic alarm signal beeps once to indicate that the control unit is functioning correctly.
 - The "Start" LED  flashes and the temperature display shows the actual set temperature flashing for about 3 seconds. Then the current temperature of the heating profile is indicated.
6. Press the "Set" button  to select another set temperature if needed.
7. Press the "Start" button  to switch the ASTOFLO PLUS ECO to **Heating Mode** ("Start" LED  illuminates).



- As long as the temperature of the heating profile is below 18 °C, the display indicates low by displaying "L".
- The temperature of the heating profile can be changed during operation at any time (**chapter 7 Operating states - section 7.4 Increasing/Decreasing the set temperature**).
- The displayed temperature shows the temperature of the Heating Profile. **This is not equal to the blood or patient's temperature!**

9.2 Priming, inserting the infusion line and starting the infusion

WARNING

Risk of overheating!

Do not insert the blood return line in the wrong flow direction. The flow direction must be from the control unit to the free end of the heating profile.

WARNING

Risk of infection!

Use aseptic procedures.

WARNING

Risk of haemolysis!

Make sure that the infusion line is not kinked.

WARNING

Risk of air embolism!

- When fluids are warmed up, it is possible that gas may evolve (bubbles form).
- Be aware of the potential for air emboli when using a blood and fluid warmer.
- Therefore fully prime all filters, lines and disposable sets before starting a treatment.
- Make sure all connections of the complete fluid stream are fixed tightly to prevent fluid leakages and inadvertent infusion of air into the fluid stream.
- Do not warm infusions containing soluted gas (e.g. bicarbonate).
- Extreme care should always be taken to ensure that a bolus of air does not pass to the patient.

CAUTION

Risk of hypothermia!

- When ASTOFLO PLUS ECO is used, the patient's body temperature must be monitored at regular intervals.
- The specified heating performance will only be achieved by inserting the infusion line into the entire length of the heating profile.
- The temperature control of the ASTOFLO PLUS ECO controls and monitors the temperature of the heating profile, but not the patient's body temperature.
- If the ASTOFLO PLUS ECO cannot be started or if the patient's temperature balance is insufficient, consider the use of alternative warming methods in order to avoid or reduce hypothermia or to improve the patient's well-being.

1. Prime the infusion line before or after inserting into the heating profile: Allow fluid to flow until no air is observed in the infusion line and the line is primed with fluid.



To facilitate insertion of the infusion line, the heating profile can be dusted with usual in trade powder or talcum powder.

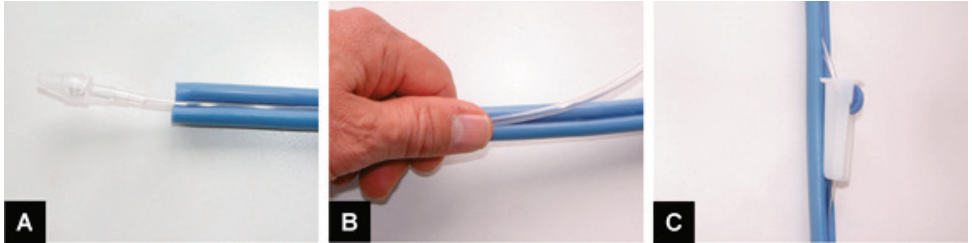

Fig. 8 Inserting infusion line

2. Start inserting the infusion line at the free end of the heating profile, about 3 cm to 5 cm behind the luer locks connection (Fig. 8 A) of the infusion set.
3. With the thumb, insert the infusion line into the groove heating profile (Fig. 8 B).
4. The best performance is achieved when as much as possible infusion line is inserted in the heating profile. Roller clamps can protrude from the profile at any point (Fig. 8 C).

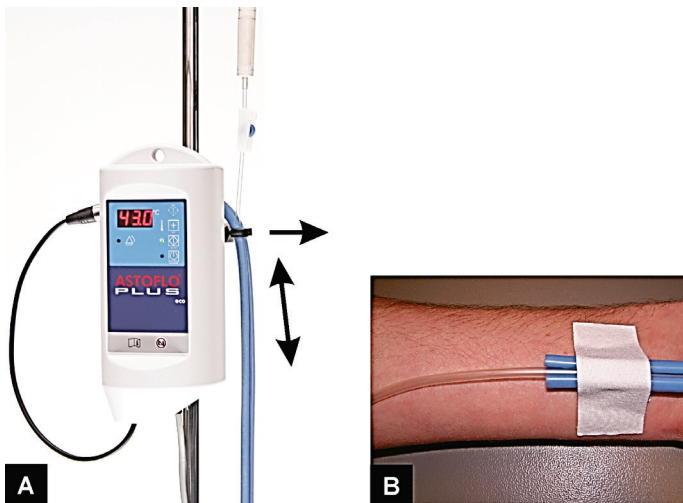

Fig. 9 Fixing the heating profile

5. Fix the heating profile/infusion line in the desired length with the clip (Fig. 9 A). The opening of the groove must be orientated to the front to allow a smooth guidance of the infusion line without kinks.

- Connect the infusion line to the patient cannula and fix the patient's end of the heating profile in position e.g. with narrow tape (Fig. 9 B). The heating profile is now free hanging between the end fixed at the patient and the control unit and the treatment can be started.

CAUTION

Risk of needle dislodgement!



The weight of the heating profile pulls on the patient's infusion line. Carefully secure the patient's access against pulling. Attach the heating profile by suitable methods (e.g. tape, plaster or Velcro®).

WARNING

Risk of overheating!

- The heating profile must hang freely while in use. Do not kink, cover (not even partially), clamp (for example, with a surgical clamp) or roll the heating profile.
- Do not place the heating profile under or directly beside the patient. Heat build-up can occur and/or the infusion line can be squeezed off.
- Do not cool or expose to cool temperatures (e.g. by evaporating disinfectants) the area near the temperature sensors (the last 40 cm of the free end of the heating profile).

9.3 After use

- Discontinue infusion.
- Press the "Standby" button  to switch off the ASTOFLO PLUS ECO (all indicators turn off, the "Standby" LED  turns on).



To disconnect ASTOFLO PLUS ECO from the mains, it is necessary to completely pull out the plug.

- Disconnect the infusion line from the cannula and simply pull the infusion line out of the ASTOFLO PLUS ECO heating profile.
- Clean and disinfect the control unit and the heating profile after each treatment and if required.

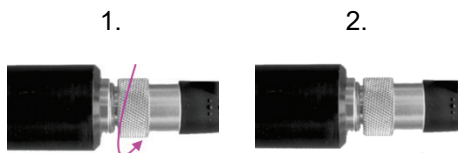

Fig. 10 Disconnecting heating profile from control unit



To disconnect the heating profile, proceed according fig. 10.

 **WARNING****Risk of infection!**

Carefully clean and thoroughly disinfect the device after every use and before returning it for any repairs.

NOTICE

To avoid damaging during storage, place the heating profile loosely around the control unit and do not kink or clamp it. Use narrow plaster strips or other narrow, soft fixation methods (for example cannula fixation, tube holder or Velcro®) to fix the heating profile.

9.4 Cleaning and disinfecting**NOTICE**

To avoid damage to the warmer:

- Do not immerse the control unit or the heating profile in liquid.
- Do not disinfect the warmer with these methods/products:
 - Steam (autoclave)
 - Hot air
 - Thermo-chemical cleaning solutions
- Refer to the specific instructions for use of the disinfectants.

 **CAUTION****Risk of injury!**

Damage to the heating profile can cause overheating, therefore follow the instructions below:

- Only disinfect the heating profile with alcohol-based agents or an approved disinfectant.
- Do not use solutions containing hypochlorite (bleach) for disinfecting the heating profile.
- Do not kink or pull the heating profile excessively.
- Do not use any clamps or sharp instruments on the heating profile as damage to the profile or the infusion line inside may result.
- Use narrow plaster strips or other narrow, soft fixation methods (for example cannula fixation, tube holder or Velcro®) to fix the heating profile.
- Do not use cleaning and disinfection procedures which differ from the procedure described.

Control Unit

Clean and wipe-disinfect the control unit in accordance with the procedure below:

1. Disconnect the mains plug from the socket.
2. Clean all surfaces including with a soft cloth/cotton swab and mild soap-and-water solution.
3. Disinfect the **control unit** with either:
 - An approved disinfectant
 - An alcohol-based disinfectant with a low content of aldehydes (< 0.2%)
 - A mild bleach solution (max. 0.25 % hypochlorite)

Heating Profile

Clean and wipe-disinfect the heating profile in accordance with the procedure below:

1. Clean all surfaces of the heating profile including the groove with a soft cloth/ cotton swab and a mild soap-and-water solution or with water only.
2. Disinfect the **heating profile** only with approved disinfectants or with disinfectants based on alcohol with a low content of aldehyds (< 0.2 %).

Do not disinfect the heating profile with disinfectants containing hypochlorite (bleach).

In doing so follow the contact time of the disinfectant given in the specific instructions for use of the disinfectant! After this time dry the heating profile.

3. Residuals of disinfectants cause a sticky surface, it is strongly recommended to rinse with water after about 5 disinfections or once a week.



To facilitate insertion of the infusion line, the heating profile can be dusted with usual in trade powder or talcum powder.

List of approved disinfectants*:

- Meliseptol®
- Biguamed® Perfekt N
- Mikrozyd® Liquid
- Bacillo® Plus
- Mikrobac® forte
- ClearSurf®
- Clinell Universal Sanitising Wipes
- Clinell Alcohol Wipes
- Incidin® Plus
- HyPro medical 3% H₂O₂
- Aniosurf
- Oxivir Tb
- Diosol 3% H₂O₂ PURE
- Virox5 RTU

*In the United States please use only disinfectants which are registered by EPA (U.S. Environmental Protection Agency) or cleared by FDA (U.S. Food & Drug Administration).

10 Alarms and troubleshooting

In the event of device failure, two independent monitoring systems ensure the safety against overheating. Except for the low temperature alarm, all alarms switch off immediately the heating function. Thus, the overheating of the heated liquid is surely prevented.

ASTOFLO PLUS ECO does not require continuous supervision by the operator, but must be inspected at regular intervals (depending on the condition of the patient). Then the intended operator's position is directly in front of the control panel.

In case of failure of the equipment, possible injury to the patient is delayed and the operator has sufficient time to provide alternative warming methods.

According to IEC/EN 60601-1-8 the alarms are defined as “**low priority alarms**”

The alarms are only triggered by technical alarm conditions (equipment faults). The alarm signal is given visually and acoustically.

Alarm signal	Characteristics
visible	yellow LED lights constantly
audible	Sound pulse, all 16 sec.

10.1 Low temperature alarm	
Control panel	<p>The diagram shows a control panel with a digital display showing 'LO' and a temperature symbol (°C). Below the display is an 'ALARM' indicator with a triangle symbol. To the right of the display are several buttons: a 'SET' button with a plus sign, a 'START' button with a square and diamond symbol, and a 'STANDBY' button with a power symbol. Circled numbers 1 through 8 point to various components: 1 (power), 2 (standby), 3 (start), 4 (start button), 5 (alarm LED), 6 (set button), 7 (display), and 8 (temperature symbol). A speaker icon is shown to the right of the panel.</p>
Device response	<p>This alarm is signaled with a 10 minute delay.</p> <ul style="list-style-type: none"> • Then the display (7) alternately indicates the current temperature and the symbol LO after 10 minutes. • The “Start” LED (3) is on. • The “Alarm” LED (5) is on. • The acoustic alarm signal is triggered and there is a brief audible beep every 16 seconds. • The heating element is <u>not</u> switched off.
Alarm condition	<p>The current temperature of heating profile is longer than 10 minutes below the limit of the low temperature alarm during Heating mode. The limit of the low temperature alarm is 3°C below the set temperature.</p>
Possible reason(s) ► Required action(s)	<p>Ambient temperature too low. ► Select warmer location</p> <p>Heating profile defective ► Return the heating profile to local sales office.</p> <p>Connection cable for heating profile defective ► Return the control unit to local sales office.</p>
Possible actions to clear	-

10.2 Overheating alarm	
Control panel	
Device response	<ul style="list-style-type: none"> • The display ⑦ alternately indicates the current temperature and the symbol HI. • The “Start” LED ③ flashes. • The “Alarm” LED ⑤ turns on. • There is a brief acoustic alarm signal every 16 seconds. • The heating element is switched off. • The device cannot be restarted (and the alarm status cannot be deactivated) until the temperature has dropped below the alarm limit.
Alarm condition	The temperature of the heating profile rises to the alarm limit of 43.6°C ± 0.5°C
Possible reason(s) ▶ Required action(s)	<p>Effect of external heat source, such as sunlight or radiator.</p> <p>▶ Eliminate the heat source and/or select cooler location.</p> <p>Ambient temperature too high.</p> <p>▶ Eliminate heat source and/or select cooler location.</p> <p>The control unit or heating profile defective.</p> <p>▶ Return the control unit/heating profile to local sales office.</p>
Possible actions to clear	<p>Press the “Standby” button ② to switch the device to Standby Mode.</p> <p>Press the “Start” button ④ to switch the device to Heating Mode.</p>
	<ul style="list-style-type: none"> • In order to prevent potential overheating due to a possible failure of the temperature control system, the ASTOFLO PLUS ECO possesses two independent excessive temperature cut offs. • If the blood return line is pulled out of the ASTOFLO PLUS ECO heating profile during use, the overheating alarm might be activated. • If the warmer is disconnected from the mains, the overheating alarm will be activated for about one second and will clear.

10.3 Cable break alarm

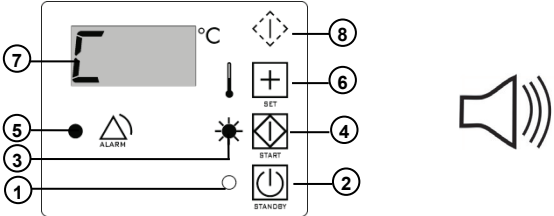
Control panel	
Device response	<ul style="list-style-type: none"> • The display ⑦ indicates the symbol C. • The “Start” LED ③ flashes. • The “Alarm” LED ⑤ turns on. • There is a brief acoustic alarm signal every 16 seconds. • The heating element is switched off.
Alarm condition	A defect of the cable break detection or a temperature sensor break has been detected.
Possible reason(s) ► Required action(s)	Control unit and/or heating profile defective. ► Return the warmer heating profile to local sales office.
Possible actions to clear	<p>Press the “Standby” button ② to switch the device to Standby Mode.</p> <p>Press the “Start” button ④ to switch the device to Heating Mode.</p>

10.4 Self-test alarm	
Control panel	
Device response	<ul style="list-style-type: none"> • The display ⑦ indicates E. • The “Alarm” LED ⑤ turns on. • There is a brief acoustic alarm signal every 16 seconds. • The control unit cannot be started.
Alarm condition	Electronics failure detected when the control unit is switched from Standby to On Mode or from On to Heating Mode or the “Start” button ④ has been pressed to soon after switching to On Mode .
Possible reason(s) ► Required action(s)	<p>“Start” button ④ has been pressed too soon.</p> <p>► Repeat the procedure after clearing the alarm.</p> <p>Failure of the electronics of the control unit</p> <p>► Return the Warmer to local sales office.</p>
Possible actions to clear	Press the “Standby” button ② to switch the device to Standby Mode .

10.5 Connection alarm

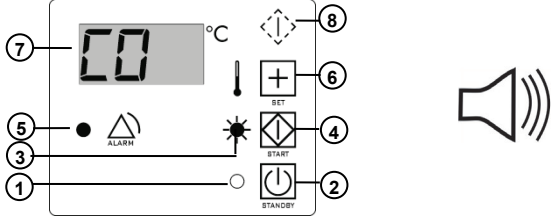
Control panel	
Device response	<ul style="list-style-type: none"> • The display (7) indicates C0. • The “Start” LED (3) flashes. • The “Alarm” LED (5) turns on. • There is a brief acoustic alarm signal every 16 seconds.
Alarm condition	<p>The heating profile is disconnected from the control unit in the Heating Mode or no heating profile is connected and the “Start” button (4) is pressed in On Mode.</p>
Possible reason(s) ► Required action(s)	<p>No heating profile is connected or heating profile became disconnected</p> <ul style="list-style-type: none"> ► 1. Connect the heating profile to the control unit. 2. Press the “Start” button (4) to switch the device to Heating Mode.
Possible actions to clear	-

10.6 Standby mode - failure	
Control panel	
Device response	The “Standby” LED ① LED is off, and the device cannot be switched to On Mode by pressing the “Standby” button ②.
Possible reason(s) ► Required action(s)	Power supply problem or no power. ► Check plugs and fuse, compare mains voltage with rating plate.
	Control unit not plugged in. ► 1. Plug the control unit into functioning socket. 2. Press the “Standby” button ②. 3. Press the “Start” button ④ to switch the control unit to Heating Mode .
	Control unit is defective. ► Return the control unit to local sales office.

10.7 On mode - failure	
Control panel	
Device response	The “Standby” LED ① is on, but the device cannot be switched to On Mode by pressing the “Standby” button ②.
Possible reason(s) ► Required action(s)	Control unit is defective. ► Return the control unit to local sales office.

12 Maintenance

ASTOFLO PLUS ECO does not require preventive maintenance (e.g. replacement of liquids or components). Recurrent tests shall be performed according to chapter 12.1.



No service or maintenance shall be carried out while in use with a patient.

WARNING

Risk of injury!

- The service personnel must be appropriately trained and qualified.
- The ASTOFLO PLUS ECO does not contain any parts the user can repair. Therefore, do not attempt to repair the ASTOFLO PLUS ECO yourself. Contact your local sales point.
- Any repairs (such as, but not limited to, changing the power supply cord) to the equipment may only be carried out by persons authorised and qualified by the manufacturer.
- Modifications to the device are not permitted.

The accessories specified in chapter 15 may be replaced without restriction by the operating or maintenance personnel.

On request, STIHLER ELECTRONIC GmbH will provide service instructions that will allow properly trained and qualified persons to repair the parts of the equipment that the manufacturer has designated as repairable.

Provision of technical documents and/or spare parts is not an authorisation from the manufacturer to open or repair the equipment.

12.1 Recurrent tests

12.1.1 Control unit (Heating profile see 12.1.2)

A recurrent test must be carried out on the ASTOFLO PLUS ECO control unit at least every 12 months to ensure the safe operation of the warmer.

Please ensure that all the applicable national directives (e.g. IEC/EN 62353) for checking the safety of medical equipment are observed additionally and that the test equipment is calibrated.

Necessary test equipment:





- Standard medical electrical safety tester
- Room thermometer
- Stopwatch

The following sections describe how the test is to be performed, and the modes of operation for the recurrent test are defined. The attached test protocol (**chapter 12.3 Test protocol**) can be used.

Test 1	Visual inspection
Required Actions	<p>Check the following items:</p> <ul style="list-style-type: none"> • Complete and legible labeling. • No damage to the housing. • Front panel in good condition. (Since the front panel prevents fluid from entering the unit, it is important that its full surface adheres securely to the housing.) • No defects in the power supply cord and mains connector insulation, with clean and non-corroded contacts.
Test 2	Protective earth resistance
Required Actions	<p>Measure the resistance between the ground pin on the power plug and the connector for potential equalization, located on the rear side of the housing.</p> <p>For detailed information performing this test see chapter 12.2 Set up for electrical safety tests.</p>
Result	The test is successful when the limits are met in accordance with the test protocol.
Test 3.1 Optional to test 3.2	Earth leakage current (direct method)
Required Actions	<p>Measure the maximum earth leakage current (PE open). Measure all combinations of line polarity with neutral open (single fault condition) and closed (normal condition).</p> <p>For detailed information performing this test see chapter 12.2 Set up for electrical safety tests.</p>
Result	The test is successful when the limits are met in accordance with the test protocol.
Test 3.2 Optional to test 3.1	Equipment leakage current (alternative method)
Required Actions	<p>Measure the current flowing from protective earthed conductor and applied part to the two (shorted) power supply connections.</p> <p>For detailed information performing this test see chapter 12.2 Set up for electrical safety tests.</p>
Result	The test is successful when the limits are met in accordance with the test protocol.

Test 4.1 Optional to test 4.2	Applied part leakage current (direct method)
Required Actions	Measure the maximum patient leakage current. Measure all combinations of line polarity with neutral open or PE open (single fault condition) as well as closed (normal condition). For detailed information performing this test see chapter 12.2 Set up for electrical safety tests .
Result	The test is successful when the limits are met in accordance with the test protocol.
	In order to facilitate this test, the silicone insulation in the heating profile is not taken into account. To do so, the heating profile would have to be immersed in saline solution or covered with aluminum foil.





Test 4.2 Optional to test 4.1	Applied part leakage current (alternative method)
Required Actions	Measure the current flowing from the applied part to protective earthed conductor and the two (shorted) power supply connection. For detailed information performing this test see chapter 12.2 Set up for electrical safety tests .
Result	The test is successful when the limits are met in accordance with the test protocol.
	In order to facilitate this test, the silicone insulation in the heating profile is not taken into account. To do so, the heating profile would have to be immersed in saline solution or covered with aluminum foil.







Test 5	Manual excessive temperature cut off
Required Actions	<ol style="list-style-type: none"> 1. Connect the heating profile. 2. Press and hold the “Test” button  continuously for at least 2 seconds while the device is started (Heating Mode). 3. Press the “Set” button  once or several times within 5 seconds until the test number (E11, E12) appears on the display. 4. Press the “Start” button  within 5 seconds to conduct a single test.
Result	<p>The test is successful when:</p> <ul style="list-style-type: none"> • The “Start” LED flashes. • The “Alarm” LED turns on. • There is a brief acoustic alarm signal every 16 seconds. • The display alternately indicates HI and a temperature inside the range of 44.0°C to 44.2°C. • All individual tests (E11 & E12) are successful. <p>The test is <u>not</u> successful if any of the following conditions occurs:</p> <ul style="list-style-type: none"> • The “Start” LED does not flash. • The “Alarm” LED does not turn on. • The acoustic alarm signal does not beep. • The display does not indicate HI. • The display indicates a temperature outside the range of 44.0°C to 44.2°C.
Test 6	Manual cable break
Required Actions	<ol style="list-style-type: none"> 1. Connect the heating profile. 2. Press the “Start” button  to switch the device from On Mode to Heating Mode to start the heating of the heating profile. 3. Observe the temperature display for 20 seconds. 4. Disconnect the heating profile.
Result	<p>If the test is successful:</p> <ul style="list-style-type: none"> • The displayed temperature rises <p>and after disconnection of the heating profile:</p> <ul style="list-style-type: none"> • The display indicates C0. • The “Start” LED flashes. • The “Alarm” LED turns on. • There is a brief acoustic alarm signal every 16 seconds.

	<p>The test is <u>not</u> successful if any of the following conditions occurs:</p> <ul style="list-style-type: none"> • The displayed temperature does not rise. • The display does not indicate C0. • The “Start” LED does not flash. • The “Alarm” LED does not turn on. • The acoustic alarm signal does not beep.
--	----------------------------------------------------------------------------------------------------------------------------------------------------------------------------------------------------------------------------------------------------------------------------------------------------------------------------------------------------------------------------------





12.1.2 Heating profile

In order to ensure the safe operating condition, the recurrent test of the heating profile must be carried out at least every 12 months.

Test 7	Visual inspection
Required actions	<ol style="list-style-type: none"> 1. Clean the heating profile with an alcohol-based agent. 2. Dust the heating profile (groove and outer side) with talcum powder. 3. Pull the entire silicone jacket through the hand and pay attention to: <ul style="list-style-type: none"> - unusual discolorations in the groove or on the outer surface of the profile - damages, scratches, cuts or open areas in the silicone profile 4. Check marking and the safety signs.
Result	<p>The test is successful, when</p> <ul style="list-style-type: none"> • no discolorations are visible • no damages are present • the safety signs are complete and legible <div style="display: flex; justify-content: space-around; align-items: center;">      </div>

Test 8	Temperature sensors of heating profile	
Preparation	<p>The safe operation of the unit depends on the accuracy of the temperature sensors. The 2 sensors can be tested by a comparison of the sensor temperatures with the room temperature. This is possible when the profile is cooled down to room temperature (20 – 26°). All measurements can only be carried out when the room has a uniform temperature and when the profile is hanging like described below.</p> <p>The heating profile must hang concentric and the thermometer for the room temperature must hang like shown in the picture. The room temperature sensor must be 70 cm away from the turning point.</p> <p>This preparation ensures that the sensors in the heating profile cool down quickly to room temperature. After that the measurements can be carried out.</p>	
	<ul style="list-style-type: none"> • Uneven temperature distribution because of opened windows or doors, incoming sunrays or other heat sources like heater fans disable this measurement. • If the test is prepared as described, the measurement can be carried out after about 30 minutes. 	
Required Actions	<p>Proper operation of the temperature sensors of the heating profile is verified through the following steps:</p> <ol style="list-style-type: none"> 1. The heating profile and the room thermometer must hang as described above. 2. Connect the heating profile to the connection cable of the control unit. 3. Press the “Standby” button  (On Mode). 4. Press the “Test” button  continuously for at least 2 seconds. <ul style="list-style-type: none"> • The display shows the temperature of the first temperature sensor and the LED “Start” turns off. 5. Press the “Set” button . <ul style="list-style-type: none"> • The display shows the temperature of the second temperature sensor. • Each time the “Set” button  is pressed, the temperature of the other temperature sensor is displayed. 6. Measure the room temperature at the specified position. 	

	<p>7. Compare the displayed temperatures of both temperature sensors with the room temperature.</p> <p>8. Press the “Standby” button  (Standby Mode).</p>
Result	<p>This test is successful when all 3 temperatures are in the range of 1.2°C (chapter 12.3 Test protocol).</p> <p>This test is not possible if:</p> <ul style="list-style-type: none"> • No heating profile is plugged in. • A temperature sensor of the plugged in heating profile is defective. <p>In this case:</p> <ul style="list-style-type: none"> • The “Alarm” LED turns on. • There is a brief acoustic alarm signal every 16 seconds. • The display indicates - - - (no heating profile is plugged in) or C (temperature sensor is defective).

Test 9	Heating-up test (Check of the essential performance)
Required actions	<ol style="list-style-type: none"> 1. Connect the heating profile to the control unit. 2. Press the “Standby” button  to switch the warmer on. 3. Press the „Set” button  to select 43°C as set temperature. 4. Press the “Start” button  to start heating. 5. Start measuring the warm-up time at 30.0°C (± 0.1°C) and measure the time until the display shows 40.0°C (± 0.1°C). 6. Observe the temperature fluctuation of the display when the set temperature of 43°C is reached.
Result	<p>The test is successful, when</p> <ul style="list-style-type: none"> • The time for heating up (30-40°C) is not longer than 150 seconds. • The displayed temperature does not differ more than ± 0.2°C from 43°C. • No alarm is indicated.
	<ul style="list-style-type: none"> • Carry out testing at room temperature (20 – 26°C). • Uneven temperature distribution because of opened windows or doors, incoming sunrays or other heat sources like heater fans disable this measurement.

12.2 Set up for electrical safety tests

For measuring the protective earth resistance, the equipment/earth leakage current and the applied part leakage current the following test set up can be used:

Test	Measurement (True RMS) (see also IEC/EN 62353)	Use connection to electrical safety analyzer
2	Protective earth resistance	Connection 1 and 3
3.1 <i>Optional to 3.2</i>	Earth leakage current N.C.	Connection 1
	Earth leakage current S.F.C (N open)	
3.2 <i>Optional to 3.1</i>	Equipment leakage current (alternative method)	Connection 1 and 2 (and possibly 3, depending on the used safety analyzer)
4.1 <i>Optional to 4.2</i>	Applied part leakage current N.C.	Connection 1 and 2
	Applied part leakage current S.F.C (PE open)	
	Applied part leakage current S.F.C (N open)	
4.2 <i>Optional to 4.1</i>	Applied part leakage current (alternative method)	Connection 1 and 2

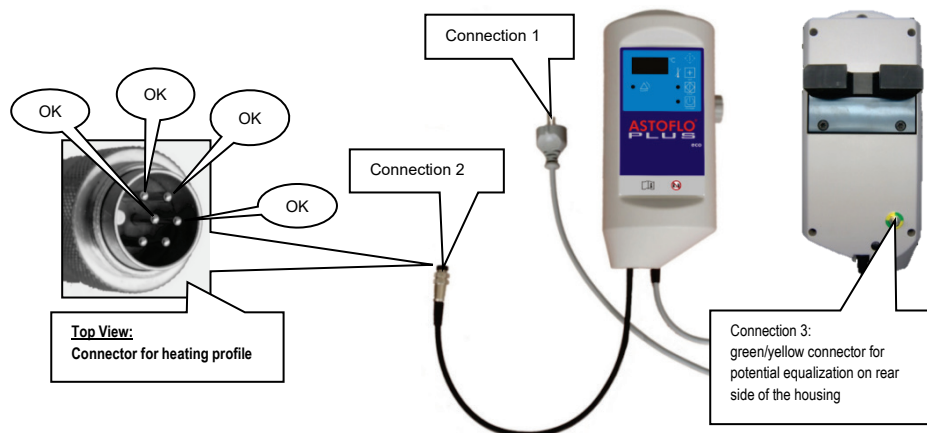

Fig. 12 Test set up for measuring



To contact the plug of the heating profile, it suffices to use one of the 4 pins (using a test tip of a standard multimeter measuring lead). These pins are marked with OK in the illustration. Be aware that the pins are not damaged

12.3 Test protocol

	Control unit	Heating profile
Type		
SN		

Test equipment	
Type	
Date of calibration	
SN	

Test 1: Visual inspection control unit				P/F
Type plate on control unit				
Front panel				
Housing				
Attachment device				
Power supply cord				
Test 2: Protective earth resistance				P/F
		Value [Ω]	Max [Ω]	
Protective earth resistance			0.3	
<input type="checkbox"/> Test 3.1: Earth leakage current (direct method) PE (Protective ground) open. Measure all combinations of line polarity.				
	Min [mA]	Value [mA]	Max [mA]	P/F
Earth leakage current N.C			0.5	
Earth leakage current S.F.C (N open)	0.010		1.0	
<input type="checkbox"/> Test 3.2: Equipment leakage current (alternative method) Optional to test 3.1				
	Min [mA]	Value [mA]	Max [mA]	P/F
Equipment Leakage Current	0.010		1.0	
<input type="checkbox"/> Test 4.1: Applied part leakage current (direct method) In this test, the insulation of silicone in the heating profile is not considered. Measure all combinations of line polarity.				
	Min [mA]	Value [mA]	Max [mA]	P/F
Applied part leakage current N.C			0.01	
Applied part leakage current S.F.C (PE open)	0.005		0.05	
Applied part leakage current S.F.C (N open)			0.05	

<input type="checkbox"/> Test 4.2: Applied part leakage current (alternative method)					
Optional to test 4.1					
	Min [mA]	Value [mA]	Max [mA]	P/F	
Applied part leakage current	0.005		0.05		
Manual tests				P/F	
Test 5: Manual excessive temperature cut off Test (E11, E12)					
Test 6: Manual cable break cut off test					
Heating profile				P/F	
Test 7: Visual inspection (damages, marking)					
Test 8: Temperature sensors heating profile		Value [°C]	Max [°C]	P/F	
Temperature sensor 1 (T1)					
Temperature sensor 2 (T2)					
Temperature thermometer (TT)					
Difference TT to T1			1.2		
Difference TT to T2			1.2		
Difference T1 to T2			1.2		
Test 9: Heating-up test		Min	Value	Max	P/F
Heating up time			min.	150 s	
Fluctuation of temperature display		42.8°C	- °C	43.2°C	
Overall assessment					
<i>Please mark where applicable</i>					
No safety or functional deficiencies were detected				<input type="checkbox"/>	
No direct risk, deficiencies detected may be corrected on short term				<input type="checkbox"/>	
Equipment must be taken out of operation until deficiencies are corrected				<input type="checkbox"/>	
Equipment does not comply – Modification / Exchange of components / Taking out of service - is recommended				<input type="checkbox"/>	
Comments					
Date	Signature				

13 Technical data

ASTOFLO PLUS ECO REF	AFP300.. AFP302..	..JA	..NA
Electrical connection		100 VAC 50 – 60 Hz	115 VAC 50-60 Hz
Fuses primary (F3, F4)		T2AH 250 V (5 x 20 mm)	
Fuse secondary (F1)		T4AH 250 V (5 x 20 mm)	
Power consumption		max. 90 W	
Classification (IEC 60601-1)		Class I, Type CF, applied part is defibrillation proof	
Classification (IEC 60529)		IPX1	
Classification (MDD 93/42/EEC)		IIb	
Code UMDNS		10-447	
Code GMDN		47616	
Applied part		supplied with 22 VAC by the control unit	
Regulatory class as per FDA		unclassified	
Dimensions (excl. heating profile)		max	
Height		280 mm	
Width		120 mm	
Depth (incl. attachment device)		175 mm	
Weight (excl. heating profile)		3 kg	
Operating mode		continuous operation	
Permissible environmental conditions		Humidity	Temperature
in operation		10% to 75% not condensing	+16°C to +38°C
in storage		10% to 75% not condensing	-20°C to +60°C
			Pressure
			700 hPa to 1060 hPa
			500 hPa to 1060 hPa
Selectable temperature of heating profile		33°C to 43°C in steps of 1°C	
Essential Performance acc. to IEC/EN 60601-1		Regulation of the temperature of the heating profile to a selectable Set-temperature between 33 °C to 43.0 °C better than +/- 1.0 °C	
1. Excessive temperature cut off		43.6°C (± 0.5°C)	
2. Excessive temperature cut off		43.6°C (± 0.5°C)	
Low temperature alarm		T _{Set} – 3°C for longer than 10 minutes	

14 Conformity with international standards

Standard	Title
IEC/EN 60601-1 ANSI/AAMI ES 60601-1 CAN/CSA C22.2 No. 60601-1	Medical electrical equipment - Part 1: General requirements for basic safety and essential performance
IEC/EN 60601-1-2	Medical electrical equipment - Part 1-2: General requirements for basic safety and essential performance - Collateral standard: Electromagnetic compatibility – Requirements and tests
IEC/EN 60601-1-6	Medical electrical equipment - Part 1-6: General requirements for basic safety and essential performance. Collateral Standard. Usability.
IEC/EN 60601-1-8	Medical electrical equipment - Part 1-8: General requirements for basic safety and essential performance - Collateral Standard: General requirements, tests and guidance for alarm systems in medical electrical equipment and medical electrical systems.
ASTM F 2172-02	Standard Specification for Blood/Intravenous Fluid/Irrigation Fluid Warmers

15 Ordering information and accessories

ASTOFLO PLUS ECO Warmer consists of a control unit and one heating profile, you can order these according the following order numbers:

REF (Order No.)	Description
AFP300xx	ASTOFLO PLUS ECO control unit for 1 changeable heating profile , connection cable heating profile 40cm.
AFP302xx	ASTOFLO PLUS ECO control unit for 1 changeable heating profile , connection cable heating profile 80cm.

- xx =**
- EU** 230 VAC, Schuko Plug
 - CH** 230 VAC, Swiss Plug
 - DK** 230 VAC, Denmark Plug
 - CN** 230 VAC, Chinese Plug
 - UK** 240 VAC, BS Plug incl. 13A fuse
 - AU** 240 VAC, Australian Plug
 - NA** 115 VAC, Hospital Grade Plug
 - JA** 100 VAC, Hospital Grade Plug

Required accessory:

REF (Order No.)	Description
WP31	Heating profile WP3 series for infusion line Ø 4-5 mm, Length: 180 cm
WP32	Heating profile WP3 series for infusion line Ø 4-5 mm, Length: 240 cm
WP33	Heating profile WP3 series for infusion line Ø 6-7 mm, Length: 180 cm
WP34	Heating profile WP3 series for infusion line Ø 6-7 mm, Length: 240 cm

We reserve the right to modify design and technical data without notice.

16 Guidelines and manufacturer's declaration

Guidance and manufacturer's declaration - electromagnetic emissions		
The ASTOFLO PLUS ECO is intended for use in the electromagnetic environment specified below. The customer or user of the ASTOFLO PLUS ECO should assure that it is used in such an environment.		
Emission test	Compliance	Electromagnetic environment - guidance
RF emissions CISPR 11/EN 55011	Group 1	The ASTOFLO PLUS ECO uses RF energy only for its internal function. Therefore, its RF emissions are very low and are not likely to cause interference in nearby electronic equipment.
RF emissions CISPR 11/EN 55011	Class A	The emissions characteristics of this equipment make it suitable for use in industrial areas and hospitals (CISPR 11 class A). If it is used in a residential environment (for which CISPR 11 class B is normally required) this equipment might not offer adequate protection to radio-frequency communication services. The user might need to take mitigation measures, such as relocating or re-orienting the equipment.
Harmonic emissions IEC/EN 61000-3-2	Class A	
Voltage fluctuations / flicker emissions IEC/EN 61000-3-3	Complies	

Guidance and manufacturer's declaration - electromagnetic immunity			
The ASTOFLO PLUS ECO is intended for use in the electromagnetic environment specified below. The customer or user of the ASTOFLO PLUS ECO should assure that it is used in such an environment.			
Immunity test	Test level	Compliance level	Electromagnetic environment - guidance
Electrostatic discharge (ESD) IEC/EN 61000-4-2	± 8 kV contact ± 2 kV, ± 4 kV, ± 8 kV, ± 15 kV air	in compliance	Floors should be wood, concrete or ceramic tile. If floors are covered with synthetic material, the relative humidity should be at least 30%.
Electrical fast transient/burst IEC/EN 61000-4-4	± 2 kV 100 kHz repetition frequency	in compliance	Mains power quality should be that of a typical commercial or hospital environment.
Surge IEC/EN 61000-4-5	± 0.5 kV, ± 1 kV Line-to-line ± 0.5 kV, ± 1 kV, ± 2 kV Line-to-ground	in compliance	Mains power quality should be that of a typical commercial or hospital environment.
Voltage dips IEC/EN 61000-4-11	0 % U _r ; 0.5 cycle At 0°, 45°, 90°, 135°, 180°, 225°, 270° and 315° 0 % U _r ; 1 cycle and 70 % U _r ; 25/30 cycles Single phase: at 0°	in compliance	Mains power quality should be that of a typical commercial or hospital environment. If the user of the ASTOFLO PLUS ECO requires continued operation during power mains interruptions, it is recommended that the ASTOFLO PLUS ECO be powered from an uninterruptible power supply or a battery.
Voltage interruptions IEC/EN 61000-4-11	0 % U _r ; 250/300 cycle	in compliance	
Rated power frequency magnetic fields IEC/EN 61000-4-8	30 A/m 50 Hz or 60 Hz	in compliance	Power frequency magnetic fields should be at levels characteristic of a typical commercial or hospital environment.
NOTE UT is the AC mains voltage prior to application of the test level.			

Guidance and manufacturer's declaration - electromagnetic immunity

The ASTOFLO PLUS ECO is intended for use in the electromagnetic environment specified below.
The customer or user of the ASTOFLO PLUS ECO should assure that it is used in such an environment.

Immunity test	Test level	Compliance level	Electromagnetic environment – guidance Recommended separation distance
Conducted disturbances induced by RF fields IEC/EN 61000-4-6	3 Vrms 0.15 MHz to 80 MHz 6 Vrms in ISM bands between 0.15 MHz and 80 MHz 80 % AM at 1 kHz	in compliance	$d = 1.2\sqrt{P}$
Radiated RF EM fields IEC/EN 61000-4-3	3 V/m 80 MHz to 2.7 GHz 80 % AM at 1 kHz	in compliance	$d = 1.2\sqrt{P}$ 80 MHz to 800 MHz $d = 2.3\sqrt{P}$ 800 MHz to 2.7 GHz

Portable and mobile RF communications equipment should be used no closer to any part of the ASTOFLO PLUS ECO, including cables, than the recommended separation distance calculated from the equation applicable to frequency of the transmitter.

Where P is the maximum output power rating of the transmitter in watts (W) according to the transmitter manufacturer and "d" is the recommended separation distance in meters (m). Field strengths from fixed RF transmitters, as determined by an electromagnetic site survey ^a, should be less than the compliance level in each frequency range ^b. Interference may occur in the vicinity of equipment marked with the following symbol:



NOTE1. At 80 MHz and 800 MHz, the higher frequency range applies.

NOTE2. These guidelines may not apply in all situations. Electromagnetic propagation is affected by absorption and reflection from structures, objects and people.

^a Field strengths from fixed transmitters, such as base stations for radio (cellular/cordless) telephones and land mobile radios, amateur radio, AM and FM radio broadcast and TV broadcast cannot be predicted theoretically with accuracy. To assess the electromagnetic environment due to fixed RF transmitters, an electromagnetic site survey should be considered. If the measured field strength in the location in which the ASTOFLO PLUS ECO is used exceeds the applicable RF compliance level above, the ASTOFLO PLUS ECO should be observed to verify normal operation. If abnormal performance is observed, additional measures may be necessary, such as reorienting or relocating the ASTOFLO PLUS ECO.

^b Over the frequency range 150 kHz to 80 MHz, field strength should be less than 3 V/m.

Recommended separation distances between Portable and mobile RF communications equipment and the ASTOFLO PLUS ECO

The ASTOFLO PLUS ECO is intended for use in the electromagnetic environment in which radiated RF disturbances are controlled. The customer or user of the ASTOFLO PLUS ECO can help prevent electromagnetic interference by maintaining a minimum distance between portable and mobile RF communications equipment (transmitters) and the ASTOFLO PLUS ECO as recommended below, according to the maximum output power of the communications equipment.

Rated maximum output power of transmitter (W)	Separation distance according to frequency of transmitter (m)		
	150 kHz to 80 MHz $d = 1.2\sqrt{P}$	80 MHz to 800 MHz $d = 1.2\sqrt{P}$	800 MHz to 2.7 GHz $d = 2.3\sqrt{P}$
0.01	0.12	0.12	0.23
0.1	0.38	0.38	0.73
1	1.2	1.2	2.3
10	3.8	3.8	7.3
100	12	12	23

For transmitters rated at maximum output power not listed above, the recommended separation distance d in meters (m) can be estimated using the equation applicable to the frequency of the transmitter, where P is the maximum output power rating of the transmitter in Watts (W) according to the transmitter manufacturer.

NOTE 1: The compliance level between 80 MHz and 2.7 GHz is intended to decrease the likelihood that mobile/portable communication equipment could cause interference if it is inadvertently brought into patient areas. For this reason, an additional factor of 10/3 is used in calculating the recommended separation distance for transmitters in this frequency range.

NOTE 2: These guidelines may not apply in all situations. Electromagnetic propagation is affected by absorption and reflection from structures, objects and people.