

en NA

Instructions for use

ASTOPAD®

Patient warming system



**DUO310-NA
COV070-NA
COV105-NA
COV150-NA
COV155-NA
COV180-NA**



STIHLERELECTRONIC

A GENTHERM COMPANY

STIHLER ELECTRONIC GmbH • 70771 Leinfelden-Echterdingen • Germany

To be completed by the user:

Serial number _____

Registration number _____

Device location _____

Start-up date _____

Manufacturer: STIHLER ELECTRONIC GmbH
Gausstrasse 4
70771 Leinfelden-Echterdingen
GERMANY
Tel. +49 (0) 711-720670
Fax +49 (0) 711-7206757
www.stihlerelectronic.de
E-Mail: info.ste@gentherm.com

CONTENTS

1 Information about these Instructions	5
2 General information	5
2.1 Guarantee conditions	5
2.2 Liability	5
2.3 Disposal of the equipment	6
2.4 Information on battery disposal	6
2.5 Return of a used product	6
2.6 Service information	7
3 Important safety information	7
3.1 Dangers	7
3.2 Warnings	8
3.3 Cautions	11
3.4 Notices	13
4 Intended Use	13
4.1 Contraindications	13
4.2 Possible adverse effects	13
4.3 Intended patient group	14
4.4 Intended body part	14
4.5 Intended user profile	14
4.6 Intended environment of use / operation	14
5 Symbols	15
6 Product description	18
6.1 Introduction	18
6.2 Technical description	18
6.3 Components of the ASTOPAD	19
6.4 Control panel	21
7 Operating states	22
7.1 Standby mode	22
7.2 On mode	23
7.2.1 On mode (no applied part connected)	23
7.2.2 On mode (one applied part connected)	24
7.3 Heating mode output A and/or B	25
7.4 Increasing/decreasing the set temperature	26
7.5 Switching off an output (A or B)	27
7.6 Operation independent of the mains (only for devices with a battery)	28
7.6.1 Display battery charge level	28
7.6.2 Charge battery	28
7.6.3 Switch to storage/transport mode	29
8 Installation	30
8.1 Putting into service	30
8.2 Installation of the Control unit	30
9 Getting started	31
9.1 Preparation for use	33
9.2 Starting the heating process	34
9.3 Selecting a new set temperature	35
9.4 Switching off an output	35
9.5 Switching off the ASTOPAD	35
9.6 Cleaning and disinfection	35
9.7 Handling and storage	38

10 Alarms and troubleshooting	39
10.1 Low temperature alarm A1 (low priority alarm)	40
10.2 Overheating alarm A2 (low priority alarm)	41
10.3 Time alarm A3 (low priority alarm)	42
10.4 Overheating alarm shut-off A4 (medium priority alarm)	43
10.5 Sensor defect alarm A5 (medium priority alarm)	44
10.6 Heater defect alarm A6 (medium priority alarm)	45
11 Information messages and troubleshooting	46
11.1 Battery status (only for devices with a battery)	46
11.2 Applied part temperature too low	46
11.3 Applied part temperature too high	47
12 Brief overview of operating states and alarms	48
12.1 Overview of operating states	48
12.2 Overview of alarms	50
13 Maintenance	51
13.1 Recurrents tests	51
13.2 Replacing the battery	52
14 Technical data	53
15 Conformity with international standards	56
16 Ordering information and Accessories	57
17 Guidelines and manufacturer's declaration	58

1 Information about these Instructions



- Carefully read the entire instructions for use before using the device.
- Correct and safe operation can only be guaranteed if the instructions for use are observed.
- Incorrect use can result in damage to the product or to other property and/or personal injury.
- Keep the instructions for use for future reference.
- Only use the device for the intended purpose as described in these instructions for use. Please refer to the section **4 Intended use**.

2 General information

2.1 Guarantee conditions

The guarantee period is 12 months. During this guarantee period the manufacturer will repair or replace free of charge all defects caused as a result of material or manufacturing errors.

Other damage is not subject to this guarantee. The guarantee does not include cases of misuse or incorrect handling, use of force, or damage caused by normal wear and tear. This applies also to changes undertaken by persons who are not authorized by the manufacturer and to modifications to the original condition.

If the equipment is damaged during the guarantee period, send the cleaned equipment to the nearest sales point or directly to STIHLER ELECTRONIC GmbH. The sender is responsible for any transport and packaging costs.

2.2 Liability

The manufacturer is only liable for the safety, reliability and performance of the equipment

- if all operating, servicing, and calibration procedures have been carried out by trained and qualified persons according to the procedures published by the manufacturer;
- if only original spare parts have been used to replace components as needed;
- if assembly and repairs are only carried out by authorized personnel or an authorized service center;
- if the electrical installations satisfy the locally applicable regulations and the IEC requirements and
- if the equipment is used for its intended purpose and at a suitable location in accordance with the instructions for use.

2.3 Disposal of the equipment

Electrical devices are recoverable waste and should not be disposed of in domestic waste at the end of their service life. Please follow the local rules for the disposal of used products or send the cleaned and disinfected equipment with a corresponding note to STIHLER ELECTRONIC GmbH or your closest sales point. This will ensure the most cost efficient and proper disposal of your old equipment.



Follow the national regulations on the disposal of medical products.

2.4 Information on battery disposal

Batteries must not be disposed of in domestic waste. The user is obliged to carry out proper disposal. Returns can be made to public communal collection points or wherever the batteries are sold.



Observe the markings printed on the battery.

Please refer to section 13.2 for instructions on removing the battery.

2.5 Return of a used product

A report must be sent together with the equipment, detailing the precise reasons, circumstances, and, if known, the cause of the return. To prevent transportation damage, the equipment should be shipped either in the original packaging or in other, well-protected packaging.

Transport rule for the return of device with built-in battery:

When returning an ASTOPAD control unit, it is essential to ensure that the control unit is in a state in which it can be stored/transported (see section **7.6.3 Switch to storage/transportation mode**).

WARNING

Risk of infection!

Clean and disinfect ASTOPAD after every use and before you return ASTOPAD for repairs.

NOTICE

The customer is responsible for the proper packaging and labelling of returns.

2.6 Service information

For service or technical support in United States and Canada, please contact your local sales point or the following:

Gentherm Medical LLC.	Telephone	1-513-772-8810
12011 Mosteller Road	Toll Free (U.S.)	1-888-437-5608
Cincinnati, OH 45241	Fax	1-513-772-9119
USA	E-Mail	medical@genthermcsz.com

Visit our Web Site at www.gentherm.com

Before you call a service ...

To help us better serve you, please have the serial numbers of your ASTOPAD patient warming system (control unit & applied part) ready when you call for parts or service. The serial number is located on the type label attached the control unit's rear and on the backside of the junction block of the applied part.

3 Important safety information

These instructions for use define and refer to the following safety information.

DANGER

DANGER indicates a hazardous situation which, if not avoided, will result in death or serious injury.

WARNING

WARNING indicates a hazardous situation which, if not avoided, could result in death or serious injury.

CAUTION

CAUTION indicates a hazardous situation which, if not avoided, could result in minor or moderate injury.

NOTICE

NOTICE indicates information considered important, but that does not relate to patient risks (e.g. a property damage message).

3.1 Dangers

DANGER

Explosion hazard!

Do not use the ASTOPAD patient warming system in an explosion-hazard environment or in the presence of flammable anesthetics.

3.2 Warnings



Risk of injury!

- ASTOPAD is only to be used under the direction of a Licensed Healthcare Practitioner.
- Read and observe all instructions, stickers, and accompanying documentation enclosed with ASTOPAD. Failure to observe the instructions, including warnings and safety information, can result in incorrect handling, patient injury, injury to users or medical personnel, damage to the device, or material damage.
- Operate and service ASTOPAD only in accordance with the procedures described in these instructions and with the applicable standards, rules, and guidelines. The manufacturer shall not be responsible for the safety of users or patients if any actions/procedures other than those published are carried out during operation, servicing, or recurrent test.
- ASTOPAD may only be operated by appropriately trained and medically qualified healthcare professionals.
- ASTOPAD may only be serviced by appropriately trained and medically qualified service personnel.
- If the OR table top is tilted (adjusted through the longitudinal axis), there is a chance that the patient will slip off. The patient must be sufficiently secured against slipping before the OR table top is tilted or otherwise moved out of the horizontal position.
- Due to the physico-chemical properties of disinfectants, ensure that disinfectants do not accumulate beneath the patient. During use, the patient must not be moist or even wet when lying on the ASTOPAD applied part. This presents a chemical burn hazard.
- When RF surgical instruments or endocardial catheters are used, the patient must also be properly insulated. This insulation must not be damp. The equipment manufacturer's instructions for use must be observed at all times.
- With transdermal drug applications (patches), the additional heat can increase the uptake of the drugs and result in injury to the patient.
- In the case of arterial occlusion, the ASTOPAD applied parts may not be used distal to this area.
- Overheating of ischemic extremities can occur with the use of the ASTOPAD applied parts.
- ASTOPAD does not contain any parts the user can repair. Therefore, do not attempt to repair ASTOPAD yourself. Contact your local sales point.
- Any repairs to ASTOPAD may only be carried out by persons authorized and qualified by the manufacturer.
- Modifications to ASTOPAD are not permitted.

 **WARNING****Risk of injury!**

- When ASTOPAD COV applied parts are used as an over-blanket, ensure that they do not obstruct the patient's field of vision.
- Do not use the ASTOPAD until the following error conditions have been remedied through appropriate corrective action:
 - Damaged or worn cables, plugs, or connecting socket.
 - Damaged housing, damaged or loose control panel.
 - Damaged or missing markings/safety signs/warnings.
 - Damaged outer cover of ASTOPAD applied parts.
 - No visual or audible alarm activated after switching on via the Standby button (self-test defective).
 - Button(s) which do not function correctly.
 - ASTOPAD has been exposed to mechanical impact or extreme amount of liquid.
 - ASTOPAD has given someone an electric shock.
 - ASTOPAD appears to have overheated.
 - ASTOPAD has triggered an alarm shut-off.
- The extension connection cable and the mains cable should not touch the patient and should not hinder the treating personnel.
- If the ASTOPAD control unit with battery installed is not used for a longer period, the battery must be removed.
- Keep ASTOPAD outside the MR Scanner room. ASTOPAD is not intended to enter the Magnetic Resonance (MR) environment.

 **WARNING****Risk of overheating!**

- For patients from 35 to 90 cm in length/height, use only the ASTOPAD COV070-NA applied part.
- Do not use ASTOPAD COV105-NA or COV150-NA or COV155-NA or COV180-NA applied parts for patients under 90 cm in length/height.

 **WARNING****Risk of infection!**

- Use aseptic procedures.
- Clean and disinfect the ASTOPAD after every use and before you return ASTOPAD for repairs.
- Place the extension connection cable between the ASTOPAD applied part and the ASTOPAD control unit in such a way that it is protected from soiling of blood and body fluids.
- Ensure that the cables do not touch the floor.

 **WARNING****Risk of infection!**

It is recommended to always place a waterproof and absorbent barrier between the patient and the ASTOPAD applied part.

 **WARNING****Risk of decubitus ulcer!**

- Regardless of the treatment duration, aged, paralyzed, comatose, and cachectic patients are particularly at risk of decubitus ulcers. Critical points should therefore also be constantly examined by medical personnel.
- Never operate ASTOPAD applied parts when folded or bent under the patient.
- Do not place the patient on the connection block of the ASTOPAD applied part.
- When the ASTOPAD applied parts are used as an under-blanket, ensure that they are placed flatly underneath the patient, are secured, and will not crease.
- In all surgical interventions it is important to ensure that sufficient measures are taken to prevent decubitus ulcers in accordance with the patient's positioning.
- The risk of skin irritation caused by pooling of surgical prep solutions under the patient may increase with warming; ensure that surgical prep solution instructions for use are followed.
- Reduce or eliminate the risk of heating skin under pressurized bony prominences.
- Do not place any hard objects (e.g. connection cables, ECG cables, hard cautery return pads, patient fluid lines, etc.) between the ASTOPAD applied part and the patient.
- ASTOPAD applied parts can be wrapped around the patient. However, take care that the applied part will not form creases.

 **WARNING****Risk of electric shock!**

- To avoid the risk of electric shock, this equipment must only be connected to a supply mains with protective earth.
- Do not use mains adapters that interrupt the earth conductor.
- Do not open the ASTOPAD control unit housing.
- If several pieces of equipment are combined or connected together (e.g., in multiple socket outlets), the total leakage currents must not exceed the allowable limits (refer to the respective national regulations). Observe the requirements as stipulated in IEC 60601-1 regarding medical electrical systems.
- All electrical installations must conform to the applicable electrical standards and the specifications defined by the manufacturer.

 **WARNING**
Risk of electric shock!

- Before every use, check to make sure that the ASTOPAD control unit and the ASTOPAD applied parts are undamaged.
- The mains plug must be removed from the socket to fully disconnect ASTOPAD from the mains.

 **WARNING**
Risk of radio interference!

- Use of ASTOPAD adjacent to or stacked with other equipment should be avoided because it could result in improper operation. If such use is necessary, ASTOPAD and the other equipment should be observed to verify that they are operating normally.
- Simultaneous use with very sensitive medical products (e.g. cardiac pacemakers, patient monitors, etc.) can lead to malfunctions. Therefore, careful monitoring of the patient is required.
- Use of accessories, transducers and cables other than those specified or provided by the manufacturer of ASTOPAD could result in increased electromagnetic emissions or decreased electromagnetic immunity of this equipment and result in improper operation.
- Portable RF communications equipment (including peripherals such as antenna cables and external antennas) should be used not closer than 30 cm (12 inches) to any part of ASTOPAD, including cables specified by the manufacturer. Otherwise, degradation of the performance of ASTOPAD could result.

3.3 Cautions

 **CAUTION**
Risk of injury!

- Federal law (USA) restricts this device to sale by or on the order of a Licensed Healthcare Practitioner.
- When installing the ASTOPAD control unit on an infusion stand, observe the instructions from the infusion stand manufacturer regarding maximum load and tilting stability.
- When ASTOPAD applied parts are used on the OR table, the OR table must be prepared according to the customary regulations and guidelines.
- Never insert pointed or sharp objects into ASTOPAD applied parts or damage the surface of the parts in any other way.
- Damage to the ASTOPAD applied part can cause overheating, therefore:
 - Avoid mechanical stress, e.g. kinking, clamping, pinching, cutting (please refer to chapter 9.7 Handling and storage).
 - Avoid chemical stress, e.g., unsuitable cleaning and disinfection agents and procedures (please refer to chapter 9.6 Cleaning and disinfection).

 **CAUTION****Risk of hypothermia!**

- If the alarm shut-off of the ASTOPAD is triggered at one output, the heating process is interrupted at both outputs.
- If thermally conductive materials, such as water, gel, and similar substances, are used and were not pre-heated, the patient's body temperature may reduce as a result once the ASTOPAD applied parts are switched off.
- When ASTOPAD is used, the patient's body temperature must be monitored at regular intervals.
- The temperature control of ASTOPAD controls and monitors the temperature of the applied parts, but not the patient's body temperature.
- If ASTOPAD cannot be started or if the patient's temperature balance is insufficient, consider the use of alternative warming methods in order to avoid or reduce hypothermia or to improve the patient's well-being.
- When ASTOPAD is used in combination with other heat sources, an overheating alarm or an overheating alarm shut-off may occur on the ASTOPAD control unit.

 **CAUTION****Risk of misinterpretation!**

Shadows of the internal wiring and sensors may appear in diagnostic images (CT, Xray) acquired while using the ASTOPAD applied parts. Images should be inspected by clinical professionals to determine the quality and diagnostic capability of image.

 **CAUTION****Risk of radio interference!**

- The essential performance can be lost or degraded due to EM disturbances. As a result, there is the possibility of hypothermia of the patient.
- According to the Standard IEC 60601-1-2, medical electrical equipment requires special precautions regarding electromagnetic compatibility (EMC) and needs to be installed and put into service according the EMC information provided.
- ASTOPAD may cause radio interferences or can interfere with the operation of devices in the vicinity. Appropriate measures may be necessary, such as reorienting or relocating of ASTOPAD or shielding.

3.4 Notices

NOTICE

- The specified ingress protection IPX2 for the ASTOPAD applied parts is ensured only when the connector
 - is connected to a suitable extension cable, or
 - the attached protective cap is used.
- Actions to avoid damaging ASTOPAD:
 - Do not immerse the ASTOPAD control unit and/or the ASTOPAD applied parts in liquid.
 - Do not disinfect the ASTOPAD control unit and/or the applied parts with:
 - Steam (e.g. in autoclaves)
 - Hot air
 - Thermochemical cleaning solutions
 - For the recommended cleaning and disinfection agents and procedures please refer to chapter 9.6 Cleaning and disinfection.
- The customer is responsible for the proper packaging and labelling of returns.
- The specified defibrillation protection is ensured only when the ASTOPAD applied part is connected to the extension connection cable and the ASTOPAD control unit.

4 Intended Use

The ASTOPAD Patient Warming System is intended to prevent or treat hypothermia and to provide warmth to patients. The ASTOPAD Patient Warming System is indicated for use in all areas of healthcare facilities for preventing or treating hypothermia or maintaining normothermia. The warming blankets can be used over or under the patient (pediatric and adult) by appropriately trained healthcare professionals.

4.1 Contraindications

No contraindications are known for patient warming.

4.2 Possible adverse effects

In normal use, no side effects arising from ASTOPAD are to be expected. For longer surgical procedures there is an increased pressure ulcer risk for the patient. To reduce the pressure ulcer risk, therefore, the additional use of a pressure-relieving support is recommended after an operating time of two hours.

4.3 Intended patient group

ASTOPAD must not be used for patients with a length/height of less than 35 cm.

Only the ASTOPAD COV070-NA applied parts may be used for patients with a length/height of between 35 and 90 cm.

For all other patients greater than 90 cm in length/height all available ASTOPAD applied parts can be used (COV070-NA, COV105-NA, COV150-NA, COV155-NA, COV180-NA).

4.4 Intended body part

ASTOPAD COV applied parts are intended for use underneath or over the patient, partial or complete (torso and extremities on all sites), head (without visual field).

ASTOPAD control unit, connecting cable and applied parts are not intended for direct skin contact. A thin waterproof and absorbent barrier shall always be used between applied part and patient.











4.5 Intended user profile



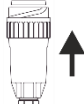













ASTOPAD may only be used by qualified medical personnel.













4.6 Intended environment of use / operation

- ASTOPAD may only be used in professional healthcare facilities (e.g. hospital, emergency care, dialysis, including HF surgical equipment, etc.).
- ASTOPAD can be used in surgical, intensive care or in patient areas in which there is a risk of cooling for the patient, or where the patient requires external warming.
- ASTOPAD is not intended for home healthcare environment.
- Appropriate medical hygienic factors must be applied for the use of ASTOPAD.
- ASTOPAD is reusable but requires cleaning / disinfection between the applications.
- ASTOPAD control unit is designed to be secured to round pipes (such as infusion stands) or on medical standard rails.
- ASTOPAD is not designed for use in incubators.
- ASTOPAD is not intended to enter the Magnetic Resonance (MR) Environment.
- ASTOPAD must not be used in an environment at risk of explosion or in the present of flammable anesthetics.
- ASTOPAD is not designed for in veterinary medicine.

5 Symbols

Symbols and indications on the control panel	
	The Standby button switches between the Standby mode and the On mode . The device is in Standby mode if the blue LED illuminates.
	Start button: Starts the heating process.
	Plus button: Temperature increase set value.
	Minus button: Temperature decrease set value.
	Stop button: Stops the heating process.
	Alarm condition when the yellow LED is lit or flashes.
	No ASTOPAD applied part is connected to the control unit.
	Wait until the temperature of the applied part rises to reach the set temperature.
	Wait until the temperature of the applied part drops to reach the set temperature.
	Battery charge level (control unit <u>not</u> connected to mains power).
	Battery charge level (control unit connected to mains power and battery is being charged).
	Battery status (defective or incorrect battery).

Where applicable, these symbols appear at the appropriate location on the patient warming system, on the packaging, on the identification plate, or in the accompanying documentation.	
	Defibrillation-proof type BF applied part in accordance with IEC 60601-1.
IPX2	Protected against dripping water in accordance with IEC 60529.
	Follow the instructions for use.
	Caution: Federal US law restricts this device to sale by or on order of a Licensed Healthcare Practitioner.
	General warning/danger symbol.
REF	Catalogue number.
SN	Serial number.
LOT	Batch code.
	Date of manufacture.
	Manufacturer.
	Distributor.
MD	Medical Device
	Information for the position of the locking ring on the cable plug of the extension connection cable.
	Battery.
	Symbol on plug connector for potential equalization in accordance with IEC 60601-1.
	Additional information.
	Electrical devices are recoverable waste and should not be disposed of in domestic waste at the end of their service life.
	Batteries and rechargeable batteries are recoverable waste and should not be disposed of in domestic waste at the end of their service life.
	Symbol for the permitted temperature range for storage and transport.
	Symbol for the permitted humidity range for storage and transport.
	Symbol for the permitted atmospheric pressure range for storage and transport.

	Transport with the arrows pointing up.
	Keep dry.
	Fragile, protect against impacts.
	Packaging Labeling for the transport of lithium batteries according to ADR SV 188 or IATA - DGR International Dangerous Goods Regulations, Packing Instruction 965, II. SECTION II 43416
	Labeling for individual shipment of lithium-Ion batteries via air freight according to IATA - DGR International Dangerous Goods Regulations, Packing Instruction 965, II. SECTION II II.2 Additional requirements 43418 / v4
	MEDICAL – GENERAL MEDICAL EQUIPMENT AS TO ELECTRICAL SHOCK, FIRE AND MECHANICAL HAZARDS ONLY IN ACCORDANCE WITH standards ANSI/AAMI ES60601-1:2005/(R) 2012 and A1:2012, C1:2009/(R)2012 and A2:2010/(R)2012, CAN/CSA-C22.2 No. 60601-1:14. Control No. 75JA
	Tilt of the OR table top.
	Acoustic alarm signal.
	No acoustic alarm signal.
	Prohibition: Do not clamp – risk of damage and possible overheating!
	Prohibition: Never insert pointed or sharp objects into the applied parts – risk of damage and possible overheating!
	Prohibition: Keep the ASTOPAD outside the MRI area.

6 Product description

6.1 Introduction

ASTOPAD consists of a control unit and optionally one or two applied parts (warming blankets).



Risk of overheating!

- For patients from 35 to 90 cm in length/height, use only the ASTOPAD COV070-NA applied part.
- Do not use ASTOPAD COV105-NA or COV150-NA or COV155-NA or COV180-NA applied parts for patients under 90 cm in length/height.

6.2 Technical description

The ASTOPAD control unit can be secured to a round pipe (e.g. infusion stand) or a medical standard rail.

The ASTOPAD control unit has two outputs (connecting sockets) A and B for connecting ASTOPAD applied parts. The desired set temperature can be selected in the range of 32.0 °C - 39.0 °C in 0.5 °C increments for each connected applied part, independently of each other, on the control panel of the control unit. The control unit can also be used with only one of the outputs, A or B. The selected set temperature and the current temperature are displayed individually for each applied part in the control panel.

The ASTOPAD control unit can also be operated via the battery option. With battery inserted, operation is possible for about 2 hours independent of the mains.

The ASTOPAD applied parts can be used as over-blankets for warming the patient from above and/or as under-blankets for warming the patient from below, with the exception of the COV155-NA warming blankets, which were exclusively designed as blankets for the upper body.

ASTOPAD does not regulate the patient's actual body temperature and does not display it. It only shows the current temperature of the active applied part.

Temperature regulation of the individual applied parts is performed with several integrated sensors.

Safety of ASTOPAD is guaranteed by the following measures per output:

- Several temperature sensors for each applied part
- Double independent sensor monitoring
- Heater monitoring
- Time shut-off
- Visual and acoustic alarm signals
- Overheating and low-temperature alarm if the contact surface temperature deviates from the temperature controller setting

6.3 Components of the ASTOPAD

Control unit



Fig. 1 Control unit

No.	Designation	Description
1	Control panel	Operating buttons and temperature displays.
2	Fastening device	For secure attachment of the ASTOPAD control unit.
3	Output A (connecting socket)	Plug-in connection to connect the applied part.
4	Output B (connecting socket)	
5	Connection for potential equalisation	The additional potential equalisation has the task of equalising potentials of various metal parts which can be touched at the same time or of reducing potential differences that can arise in the application between the body, electromedical equipment and foreign conductive parts. The connection is made via green-yellow insulated cables (min. 4 mm ²) on standardised connection bolts and connection sockets. When connecting/combining ME devices to form an ME system, the requirements of IEC 60601-1 must be observed.
6	Device plug for detachable mains connection cable with mains plug	The mains connection cable supplies the control unit with mains voltage via a plug. The device is disconnected from the power supply by pulling out the mains plug.

Applied parts



Fig. 2 ASTOPAD COVXXX-NA applied parts

No.	Designation	Description
1	ASTOPAD COV	Example of an ASTOPAD COVXXX-NA applied part
2	Connection cable	Connection cable for connecting to the extension connection cable.
3	End cap	The attached end cap is closed when no extension connection cable is connected. It protects the contacts and guarantees the IPX2 ingress protection.
4	Extension connection cable	The applied parts can be connected to the control unit with the extension connection cable.

6.4 Control panel

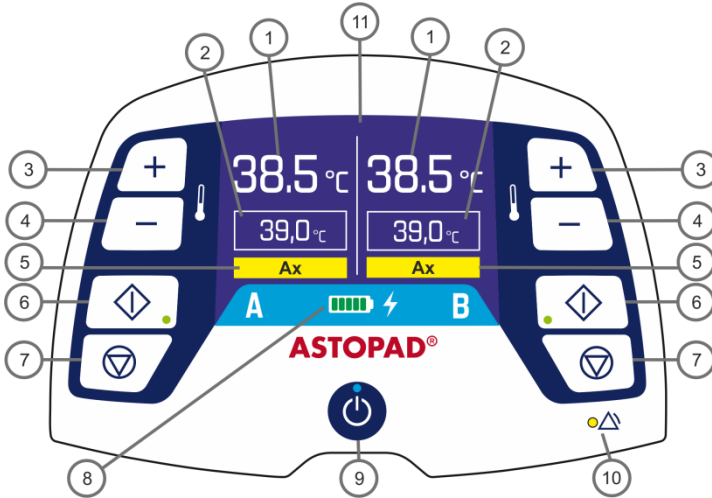

Fig. 3 Control panel



No.	Designation	Description
1	Actual temperature A or B	Displays the actual temperature of the applied part
2	Set temperature A or B	Displays the selected set temperature of the applied part.
3	Plus button A or B	Press this button to increase the set temperature in increments of 0.5 °C.
4	Minus button A or B	Press this button to decrease the set temperature in increments of 0.5 °C.
5	Alarm indicator	Displays the corresponding alarm code in an alarm situation.
6	Start button Start LED (green) A or B	Press this button to start the heating process or Press this button to confirm a change made to the set temperature.
7	Stop button A or B	Ends the heating process and switches off the respective output.
8	Battery status indicator	Indicates the current battery status.
9	Standby button Standby LED (blue)	The Standby button switches between the Standby mode and the On mode .
10	Alarm LED (yellow)	LED flashes or turns on and the acoustic alarm signal sounds when there is an alarm situation.
11	Display	Informs the user of temperatures and fault conditions.

7 Operating states

With a few exceptions, the operating states are described below when only one applied part is connected to output A of the ASTOPAD control unit and is being operated.

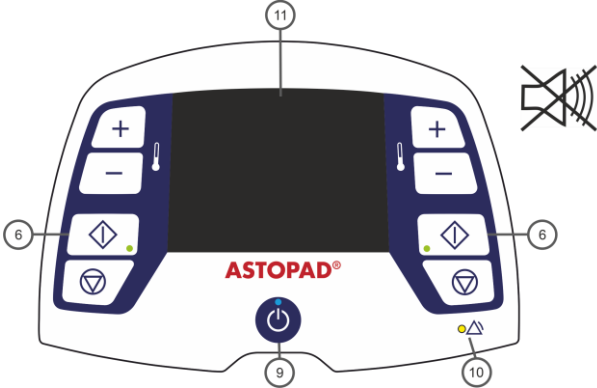

The description of the operating states applies accordingly to the connection and operation of a second applied part at output B of the ASTOPAD control unit.

7.1 Standby mode

Control panel	
Action	After connecting the mains plug to the mains socket, the control unit is in Standby mode .
Device response	<ul style="list-style-type: none"> • Standby LED (9) lights up. • Display (11) shows the symbol for battery status (only for equipment with built-in battery).
	<ul style="list-style-type: none"> • Press the Standby button (9) to switch the control unit from any mode to Standby mode. • In Standby mode only the electronics and the applied parts are disconnected from the power supply. The control unit remains connected to the mains. • For control units with a built-in battery, the battery is charged in Standby mode. • After a power failure, the control unit automatically switches to Standby mode.

7.2 On mode

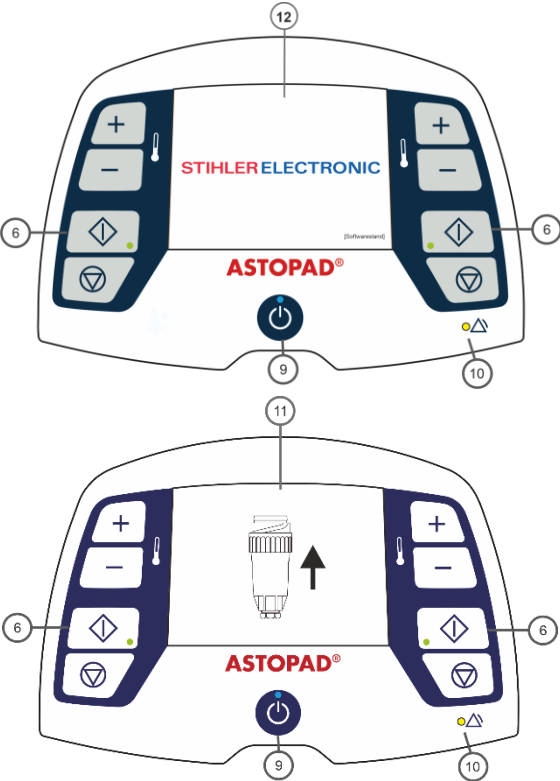
7.2.1 On mode (no applied part connected)

Control panel	
Action	Press the Standby button (9) to switch the control unit from Standby mode to On mode.
Device response	<ul style="list-style-type: none"> • Standby LED (9) goes out. • Start screen (12) is displayed for 1 second. • ASTOPAD control unit performs a self-test. LEDs (6), (10) flash once and the acoustic alarm signal sounds once, to confirm that the control unit is working properly. • If no applied part is connected to the control unit, the display (11) shows the symbol Connect applied part.
	<ul style="list-style-type: none"> • The current software version is displayed in the bottom right corner of the Start screen. • The display remains until at least one applied part is connected to the control unit.

7.2.2 On mode (one applied part connected)

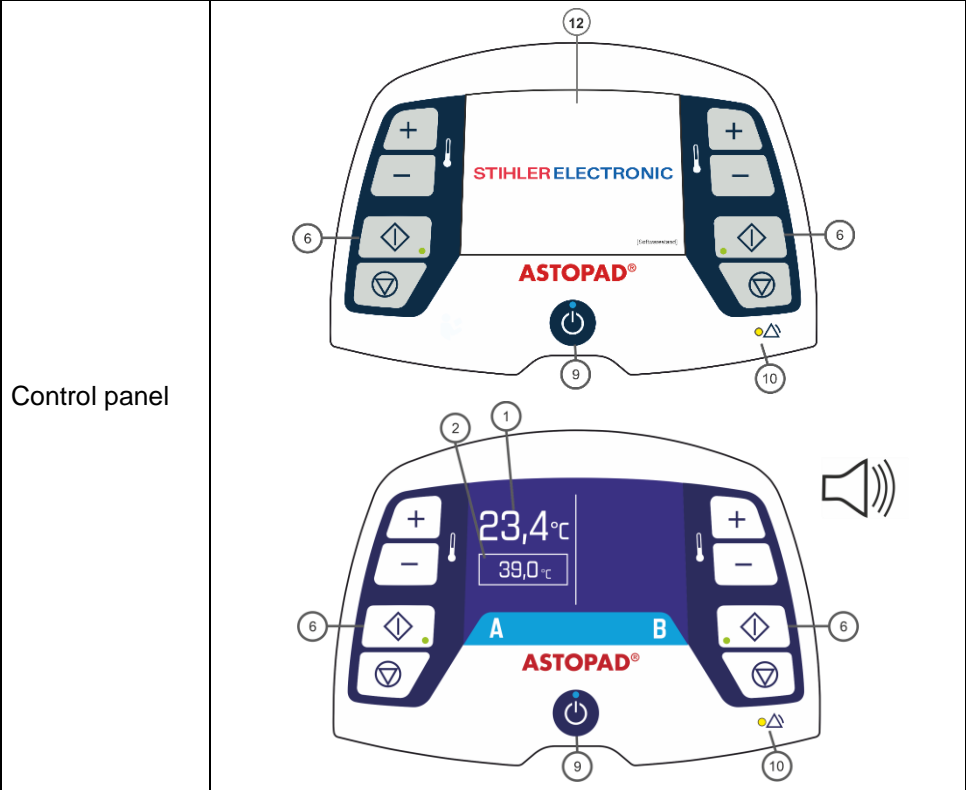



Action Press the Standby button (9) to switch the control unit from **Standby mode to On mode.**

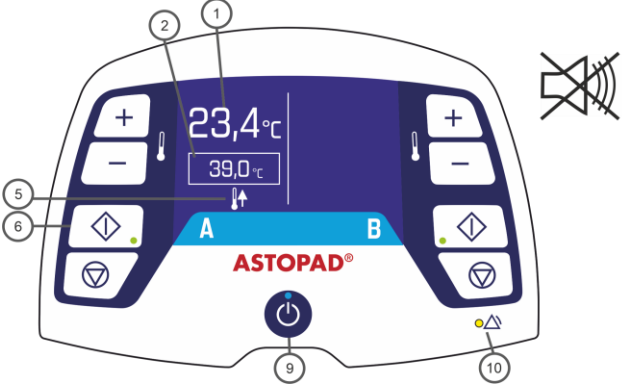

- Device response**
- Standby LED (9) goes out.
 - Start screen (12) is displayed for 1 second.
 - ASTOPAD control unit performs a self-test. LEDs (6), (10) flash and the acoustic alarm signal sounds, to confirm that the control unit is working properly.
 - The display shows the current actual temperature (1) and the stored set temperature (2).

- i**
- The current software version is displayed in the bottom right corner of the Start screen.
 - The self-test remains active until the heating process is started.
 - By pressing the Standby button and simultaneously holding the Stop output B button, the Start screen is displayed for as long as the Stop button is pressed.

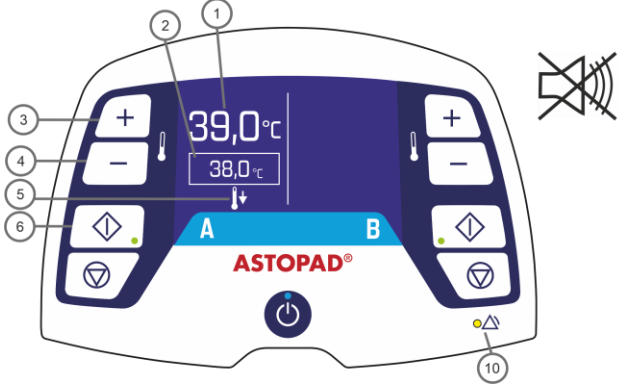

7.3 Heating mode output A and/or B

Control panel	
Action	Press the Start button (6) to start the heating process.
Device response	<ul style="list-style-type: none"> • The last set temperature (2) is loaded. • Acoustic alarm switches off, and the alarm LED (10) goes out. • When the applied part is started, the display (5) shows the applied part heating symbol , until the difference to the set temperature (2) is less than 1°C. • LED Start (6) lights up green. • Temperature control is active.
	If no applied part is connected to an output (A or B) or the heating process does not start, displays (1), (2) and (5) go off.

7.4 Increasing/decreasing the set temperature

Control panel	
Action	<ol style="list-style-type: none"> 1. Press the Plus (3) / Minus (4) buttons to raise or lower the selected set temperature in 0.5°C increments. 2. Confirm the new set temperature by pressing the Start button (6).
Device response	<ul style="list-style-type: none"> • Start LED (6) flashes green until confirmation by pressing the Start button (6). • Selected set temperature (2) is saved. • When the applied part is started, the display (5) shows the symbol \updownarrow or $\downarrow\updownarrow$, until the difference from the set temperature (2) is less than 1°C. • LED Start (6) lights up green. • Temperature control is active.
	<ul style="list-style-type: none"> • If no applied part is connected to an output (A or B) or the heating process does not start, the display (1) and (2) go off. • The set temperature can be set independently for each output A and B in the range from 32.0°C to 39.0°C.

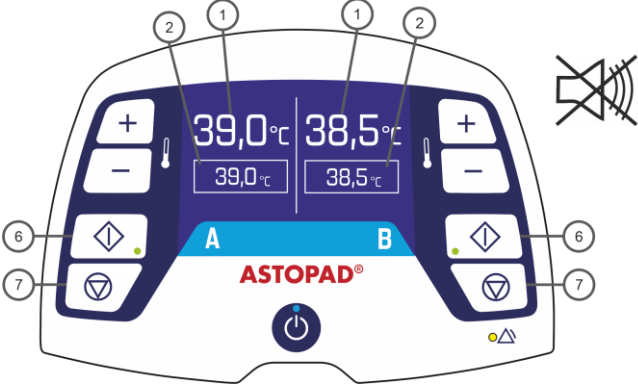
7.5 Switching off an output (A or B)

Control panel	
Action	Press the Stop button (7) to switch off an output.
Device response	<ul style="list-style-type: none"> • Start LED (6) goes out. • Displays (1) and (2) go off for the output that was switched off.
	<ul style="list-style-type: none"> • If only one output is active, pressing the Stop button (7) will deactivate the heating process of this output and activate the self-test. • Pressing the Start button (6) can reactivate the heating process with the last set temperature setting (2). • Press the Standby button (9) to switch the control unit into Standby mode.



7.6 Operation independent of the mains (only for devices with a battery)

After ASTOPAD has reached the set temperature in mains operation, ASTOPAD can be operated independently of the mains for approx. 2 hours using the battery option.

7.6.1 Display battery charge level	
Control panel	
Action	Operate control unit with one or two applied parts.
Device response	<ul style="list-style-type: none"> • Display shows the symbol battery charge level (1) 100% • Display shows the symbol battery charge level (2) 10%

7.6.2 Charge battery	
Control panel	
Action	Connect the control unit to the mains (control unit is in Standby mode).
Device response	<p>Battery fully charged:</p> <ul style="list-style-type: none"> • Display (1) shows the symbol battery charge level 100% and control unit connected to the mains. <p>Battery is <u>not</u> fully charged:</p> <ul style="list-style-type: none"> • Display (2) shows the symbol battery charge level 10% and control unit connected to the mains. Battery is being charged.

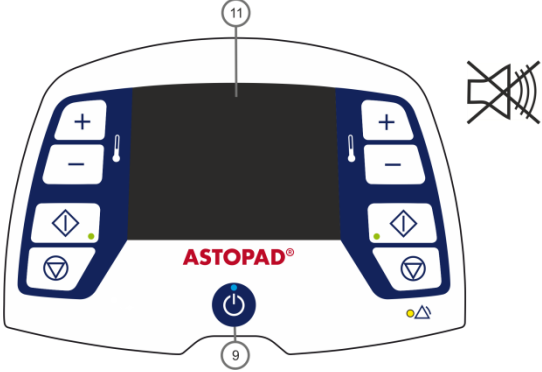
7.6.3 Switch to storage/transport mode

Control panel	
Action	Hold down Standby button (9) for at least 3 seconds.
Device response	<ul style="list-style-type: none"> • The Standby LED (9) goes out. • The display (11) turns off.
	<p>Battery discharge is reduced.</p> <p>Press the Standby button (9) for at least 3 seconds to switch on the control unit again (On mode).</p>

8 Installation

8.1 Putting into service

Before operating this device for the first time:

- Inspect the device visually (see section **13.1 Recurrent Tests**).
- Check the mains voltage (compare the data on the type label with the available mains voltage). An incorrect mains voltage can lead to destruction of the device.

National regulations may require other tests before this device can be put into service. If required, additional tests for electrical safety should be carried out according to section **13.1 Recurrent Tests**.

8.2 Installation of the Control unit

For safe installation, the control unit is equipped with a universal attachment device. With this, the device can be securely attached to infusion stands as well as to medical standard rails.



Risk of injury!

When installing the ASTOPAD control unit on an infusion stand, observe the instructions from the infusion stand manufacturer regarding maximum load and tilting stability.

8.2.1 Attachment to infusion stands



Fig. 4 Attachment to infusion stands

1. Turn the hand wheel counterclockwise to open the attachment device.
2. Turn the hand wheel clockwise to lock the attachment device to the infusion stand.
3. Check that the control unit is firmly fixed.

8.2.2 Attachment to medical rails



Abb. 5 Attachment to medical rails

1. Hang the ASTOPAD control unit obliquely from above with the attachment device into the standard rail.
2. Fix the ASTOPAD control unit by tightening the hand wheel to the standard rail.
3. Check that the ASTOPAD control unit is firmly fixed.



For attachment to the medical rail it may be necessary to move the attachment device into another position. To do this, release the fixing screws. Once the position is changed, the screws must be screwed in again according to the positioning of the attachment device.

9 Getting started

WARNING

Risk of electric shock!

Before every use, check to make sure that the ASTOPAD control unit and the ASTOPAD applied parts are undamaged.

WARNING

Risk of infection!

- Use aseptic procedures.
- Place the extension connection cable between the ASTOPAD applied part and the ASTOPAD control unit in such a way that it is protected from soiling of blood and body fluids.
- Ensure that the cables do not touch the floor.
- It is recommended to always place a waterproof and absorbent barrier between the patient and the ASTOPAD applied part.

WARNING

Risk of injury!

- Do not use the ASTOPAD until the following error conditions have been remedied through appropriate corrective action:
 - Damaged or worn cables, plugs, or connecting socket.
 - Damaged housing, damaged or loose control panel.
 - Damaged or missing markings/safety signs/warnings.
 - Damaged outer cover of ASTOPAD applied parts.
 - No visual or audible alarm activated after switching on via the Standby button (self-test defective).
 - Button(s) which do not function correctly.
 - ASTOPAD has been exposed to mechanical impact or extreme amount of liquid.
 - ASTOPAD has given someone an electric shock.
 - ASTOPAD appears to have overheated.
 - ASTOPAD has triggered an alarm shut-off.
- When RF surgical instruments or endocardial catheters are used, the patient must also be properly insulated. This insulation must not be damp. The device manufacturer's instructions for use must be observed at all times.
- With transdermal drug applications (patches), the additional heat can increase the uptake of the drugs and result in injury to the patient.
- In the case of arterial occlusion, the applied parts of the ASTOPAD may not be used distal to this area.

 **WARNING****Risk of injury!**

- Overheating of ischemic extremities can occur with the use of the ASTOPAD applied parts.
- When applied parts ASTOPAD COV are used as an over-blanket, ensure that they do not obstruct the patient's field of vision.
- The extension connection cable and the mains cable should not touch the patient and should not hinder the treating personnel.

 **WARNING****Risk of decubitus ulcer!**

- Regardless of the treatment duration, aged, paralyzed, comatose, and cachectic patients are particularly at risk of decubitus ulcers. Critical points should therefore also be constantly examined by medical personnel.
- Never operate ASTOPAD applied parts when folded or bent under the patient.
- Do not place the patient on the connection block of the applied part.
- When the ASTOPAD COV applied parts are used as an under-blanket, ensure that they are placed flatly underneath the patient, are secured, and will not crease.
- In all surgical interventions ensure that sufficient measures are taken to prevent decubitus ulcers in accordance with the patient's positioning.
- The risk of skin irritation caused by pooling of surgical prep solutions under the patient may increase with warming; ensure that surgical prep solution instructions for use are followed.
- Reduce or eliminate the risk of heating skin under pressurized bony prominences.
- Do not place any hard objects (e.g. connection cables, ECG cables, hard cautery return pads, patient fluid lines, etc.) between the ASTOPAD applied part and the patient.
- ASTOPAD COV applied parts can be wrapped around the patient. However, take care that the applied part will not form creases.



- All ASTOPAD applied parts may be operated only with the ASTOPAD control unit.
- All ASTOPAD applied parts should not come in direct skin contact with the patient and must be operated with an intermediate layer between the applied part and the patient.
- ASTOPAD COV applied parts can be used as over-blankets and/or under-blankets.
- Install ASTOPAD so that disconnection from the mains via the mains plug is difficult to carry out.
- After ASTOPAD has reached the set temperature in mains operation, ASTOPAD can be operated independently of the mains for approx. 2 hours using the battery option.

9.1 Preparation for use

- Before use, make sure that the device and its applied parts have been cleaned and disinfected according to the instructions for use (see Section **9.6 Cleaning and disinfection**).
- Apply the ASTOPAD control unit according to Section **8.2 Installation of the Control unit**.

9.1.1 Using ASTOPAD COV070-NA, COV105-NA, COV150-NA, COV180-NA as an under-blanket



Risk of overheating!

- For patients from 35 to 90 cm in length/height, use only the ASTOPAD COV070-NA applied part.
- Do not use ASTOPAD COV105-NA or COV150-NA or COV155-NA or COV180-NA applied parts for patients under 90 cm in length/height.

1. A pressure-relieving gel pad may be placed on the OR table.
2. Place the ASTOPAD applied part lengthwise on the table with the cable connection side facing the outside edge of the OR table/treatment table.
3. Position the ASTOPAD applied part on the table so that it is flat underneath the patient and will not crease. If a pressure-relieving gel pad is used in combination with the ASTOPAD applied parts on the OR table, the gel pad must be placed under the ASTOPAD applied part. Observe the arrangement of the ASTOPAD applied part and the gel pad. The gel pad and ASTOPAD applied part must be positioned flush with the head or foot end of the OR table.
4. Always place a thin waterproof and absorbent barrier (OR drape) between the ASTOPAD applied part and the patient.

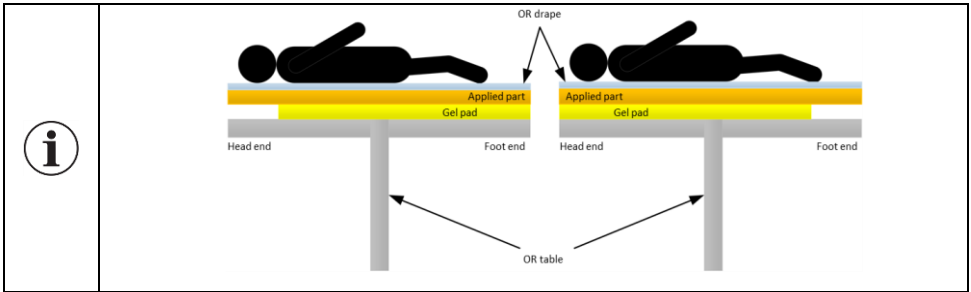

⚠ WARNING

Risk of injury!

If the OR table top is tilted (adjusted through the longitudinal axis), there is a chance that the patient will slip off. The patient must be sufficiently secured against slipping before the OR table top is tilted or otherwise moved out of the horizontal position.

9.1.2 Using ASTOPAD COV applied part as a over-blanket

⚠ WARNING

Risk of injury!

When ASTOPAD COV applied parts are used as an over-blanket, ensure that they do not obstruct the patient's field of vision.

Always place a thin waterproof and absorbent barrier between the ASTOPAD applied part and the patient.

Place the blanket lengthwise over the patient with the cable connection side facing away from the patient. If areas of the patient are to be made accessible, the direction of the blanket can be adjusted according to the operation field.

9.2 Starting the heating process



The operator should be positioned in front of the ASTOPAD control unit, able to see easily the displays and operating elements.

1. Plug the mains plug for the ASTOPAD control unit into the socket.
2. Position the patient correctly and apply the applied parts according to the particular case and according to section **9.1 Preparation for use**.
3. Connect the extension connection cable with the connection cable of the applied parts. Then secure the bayonet connector by turning it to the right.
4. Place the extension connection cable/connection cable in either output A or B; taking care that the two white dots on the plug are facing upwards. Secure the plug connection by turning it a quarter rotation to the right.
5. Switch on the ASTOPAD control unit with the Standby  button.
6. Check whether the self-test is automatically activated (display illuminates, all LEDs flash, and the acoustic alarm sounds). Only then is the ASTOPAD ready for use.



WARNING

Risk of injury!

Do not use ASTOPAD if no visual or audible alarm is activated after switching on via the Standby button (self-test defective).

7. Press the Start  button to start the heating process at output A or B with the displayed set temperature.

9.3 Selecting a new set temperature

1. Press Plus  / Minus  button to raise or lower the selected set temperature in 0.5 °C increments.
2. Confirm the new set temperature by pressing the Start  button.
The selected set temperature is stored.



9.4 Switching off an output

Press the Stop  button to end the heating process at output A or B. The display turns off.



If only one output is active, pressing the Stop  button will deactivate the heating process and will activate the self-test.

9.5 Switching off the ASTOPAD

1. Press the Standby  button of the ASTOPAD control unit to switch off (all displays are turned off, the Standby  LED illuminates).
2. Disconnect the ASTOPAD control unit from the applied part(s).

9.6 Cleaning and disinfection

During use, ASTOPAD and accessories may be unintentionally contaminated with organic contaminants (such as blood or body fluids) or microorganisms. Therefore, after each use the following cleaning and disinfecting procedures shall be followed.

While cleaning and disinfecting, wear gloves with chemical resistance.

- Always work from top to bottom and from clean to dirty areas.
- After removing blood, discard the wet wipe. Use a new one to continue cleaning.
- Use wipes only as long as they leave a closed liquid film on the surface.
- The surfaces should remain wet with the disinfectant for the tuberculocidal contact time specified in the wipe manufacturer's label instructions.
- Use adequate numbers of wipes per surface in order to achieve adequate disinfection.
- Dispose of used wipes according to the instructions of your facility.

- Follow the specific EPA label disinfectant contact times.
- Work methodically in order to disinfect each area of the device.

9.6.1 Recommended cleaning and disinfection agent

For routine disinfection use an EPA-registered intermediate level disinfectant that is labeled as tuberculocidal.

Validated disinfectant:

Sani-Cloth® GERMICIDAL DISPOSABLE WIPES

Manufacturer:	Professional Disposables International, Inc.
EPA Reg. no.:	9480-4
Disinfection level:	EPA-registered intermediate level disinfectant
Formulation:	Quaternary ammonium and isopropyl alcohol (IPA)
Active ingredients:	<ul style="list-style-type: none"> • n-Alkyl (68% C12, 32% C14) dimethyl ethylbenzyl ammonium chlorides: 0.25% • n-Alkyl (60% C14, 30% C16, 5% C12, 5% C18) dimethyl benzyl ammonium chlorides: 0.25% • Isopropyl Alcohol: 55.00%
Efficacy	Bactericidal, Tuberculocidal, Virucidal (Hepatitis B and C, HIV), Fungicidal, effective against SARS-CoV-2
Overall contact time:	2 minutes

9.6.2 Other cleaning and disinfection agents

Other disinfection agents than the one stated in chapter 9.6.1 have not been validated. EPA-registered intermediate level disinfection agents with a similar chemical composition and efficacy may also be used for routine disinfection. The overall contact time must not exceed 5 minutes.

The use of disinfectants with other chemical composition may cause chemical stress to the product. It is possible that the use of such disinfectants may reduce the expected service life, depending on the frequency of use and the age of the product. Avoid over saturation and follow all chemical manufacturer's guidelines for all disinfectants.

It is important to make sure that the ASTOPAD control unit and the applied parts are undamaged before each use and that the periodic recurrent tests are carried out properly. This is essential to detect any material deterioration or damage.

9.6.3 Cleaning and disinfecting the applied parts

1. Disconnect applied part from the control unit.
2. Close the connector using the end cap (refer to Fig. 2 ASTOPAD COV applied parts) to protect electrical contacts from entering liquids.
3. Visually inspect all surfaces (all sides) including the junction block and the connecting cable for wear and tear, cuts, holes and cracks and other unacceptable deteriorations.

Cleaning and disinfecting is possible only when no damage exists! Damaged components should not be used.

4. Thoroughly clean all surfaces (all sides) including the junction block and the connecting cable for residues of body fluids and other soiling.
5. Clean according to the instructions of the disinfectant manufacturer and then disinfect in a second step.

If the surface is not visually clean at the end of the cleaning step, the cleaning process should be either repeated or the device should be safely disposed.

6. Disinfect all surfaces (all sides) including the junction block and the connecting cable.
7. Disinfect according to the instructions of the disinfectant. When disinfecting mattresses wipe from head-end to foot-end.

The surfaces should remain wet with the disinfectant for the tuberculocidal contact time specified in the wipe manufacturer's label instructions.

8. Let air dry all parts and all sides well thoroughly before further use or storage.

9.6.4 Cleaning and disinfecting the control unit

1. Disconnect control unit from mains.
2. Visually inspect control panel and housing from all sides for wear and tear, holes and cracks and other unacceptable deteriorations.

Cleaning and disinfecting is possible only when no damage exists! Damaged components should not be used.

3. Thoroughly clean all surfaces (all sides) for residues of body fluids and other soilings.
4. Clean first according to the instructions of the disinfectant manufacturer and then disinfect in a second step.

If the surface is not visually clean at the end of the cleaning step, the cleaning process should be repeated until the housing is visually clean.

5. Disinfect all surfaces (all sides) according to the instructions of the disinfectant.

The surfaces should remain wet with the disinfectant for the tuberculocidal contact time specified in the wipe manufacturer's label instructions.

6. Let air dry control unit before further use or storage.

⚠ CAUTION

Risk of injury!

Damage to the ASTOPAD applied part can cause overheating, therefore:

- Avoid mechanical stress, e.g. kinking, clamping, pinching, cutting (please refer to chapter 9.7 storage guidelines).
- Avoid chemical stress, e.g., unsuitable cleaning and disinfection agents and procedures (please refer to chapter 9.6 Cleaning and disinfection).

NOTICE

To avoid damage:

- Do not immerse the control unit and/or the applied parts in liquid.
- Do not disinfect the control unit and/or the applied parts with these methods/products:
 - Steam (autoclave)
 - Hot air
 - Thermochemical cleaning solutions
- Refer to the specific instructions for use of the disinfectants.

9.7 Handling and storage

To reduce mechanical stress, we recommend the following storage procedure:



10 Alarms and troubleshooting

ASTOPAD does not require continuous supervision by the operator but must be inspected at regular intervals (depending on the condition of the patient). For this, the intended operating location is immediately in front of the control panel of the ASTOPAD control unit.

In the event of failure of ASTOPAD, possible injury to the patient is delayed and the operator has sufficient time to provide alternative warming methods.

To ensure the safe operation of ASTOPAD for patients and users, ASTOPAD is equipped with a series of independent alarm systems. The alarms are the result of consistent implementation of the standards listed in Section

15 Conformity with international standards.

The alarms are only triggered by technical alarm conditions (device faults). The alarm signal is given visually and acoustically.

The following only describes the behavior of the ASTOPAD control unit under alarm conditions for output **A**. The ASTOPAD control unit behaves in the same way under alarm conditions for output **B**.

10.1 Low temperature alarm A1 (low priority alarm)

<p>Control panel</p>	
<p>Alarm condition</p>	<p>The set temperature was reached once. After that, the actual temperature (1) drops by at least 1°C below the set temperature (2). $T_{Set} - T_{Actual} \geq 1^{\circ}C$. This condition remains for at least 10 minutes.</p>
<p>Device response</p>	<ul style="list-style-type: none"> • Display (5) shows A1 (flashing). • Start LED (6) flashes. • Alarm LED (10) lights up yellow. • Acoustic alarm signal is triggered.
<p>Possible reasons ▶ Required action(s)</p>	<p>Applied part is influenced by the environmental conditions (cooled). ▶ Stop cooling.</p> <p>Applied part defective. ▶ Send the applied part to the local sales point.</p>
<p>Required action(s) for resetting</p>	<p>Press the Start button (6). Low temperature alarm A1 is reset.</p>
<p></p>	<p>If the alarm conditions are not met furthermore, the display A1 and the acoustic alarm signal are automatically reset. The alarm LED continues to light up yellow to indicate a low-temperature alarm that has already been triggered.</p>

10.2 Overheating alarm A2 (low priority alarm)

<p>Control panel</p>	
<p>Alarm condition</p>	<p>The set temperature was reached once. After that, the actual temperature (1) rises by at least 1°C above the set temperature (2) and remains below 41°C. $T_{Actual} - T_{Set} \geq 1^{\circ}C$ and $T_{Actual} < 41^{\circ}C$. This condition remains for at least 10 minutes.</p>
<p>Device response</p>	<ul style="list-style-type: none"> • Display (5) shows A2 (flashing). • Start LED (6) flashes. • Alarm LED (10) lights up yellow. • Acoustic alarm signal is triggered.
<p>Possible reasons ► Required action(s)</p>	<p>Set temperature was lowered. ► Cooling phase, no action necessary.</p> <p>Applied part is being influenced by an external heat source. ► Remove the external heat source.</p> <p>Applied part defective. ► Send the applied part to the local sales point.</p>
<p>Required action(s) for resetting</p>	<p>Press the Start button (6). Overheating alarm A2 is reset.</p>
<p></p>	<p>If the alarm conditions are not met furthermore, the display A2 and the acoustic alarm signal are automatically reset. The alarm LED continues to light up yellow to display an overheating alarm that has already been triggered.</p>

10.3 Time alarm A3 (low priority alarm)

<p>Control panel</p>	
<p>Alarm condition</p>	<p>The set temperature (2) is not reached during 60 minutes of uninterrupted heating.</p>
<p>Device response</p>	<ul style="list-style-type: none"> • A3 (flashing) appears on the display (5). • Start LED (6) flashes. • Alarm LED (10) lights up yellow. • Acoustic alarm signal is triggered. • Heating process is not interrupted.
<p>Possible reasons ► Required action(s)</p>	<p>A layer of thermally conductive materials (water or gel) is situated on the applied part. ► Remove the layer or place it underneath the applied part.</p> <p>Applied part defective. ► Send the applied part to the local sales point.</p>
<p>Required action(s) for resetting</p>	<p>Press the Start button (6) to reset the alarm.</p>
<p></p>	<p>If the set temperature is not reached during 60 minutes of uninterrupted heating, the alarm is triggered again.</p>

10.4 Overheating alarm shut-off A4 (medium priority alarm)

<p>Control panel</p>	
<p>Alarm condition</p>	<p>The actual temperature (1) is higher than 41°C.</p>
<p>Device response</p>	<ul style="list-style-type: none"> • A4 (flashing) appears on the display (5). If both outputs are active, A4 is displayed for both outputs. • Start LED (6) and the Alarm LED (10) flash. • Acoustic alarm signal is triggered. • Heating process is interrupted at the two outputs.
<p>Possible reasons ▶ Required action(s)</p>	<p>Set temperature is increased. Applied part produces a temperature overshoot.</p> <ul style="list-style-type: none"> ▶ 1. Switch off the control unit with the Standby button (9). 2. Allow the applied part to cool. 3. Restart the heating process. <p>Applied part is influenced by the environmental conditions (heat source).</p> <ul style="list-style-type: none"> ▶ Remove heat source. <p>Applied part defective.</p> <ul style="list-style-type: none"> ▶ Send the applied part to the local sales point.
<p>Required action(s) for resetting</p>	<p>Switch off the control unit with the Standby button and allow the applied parts to cool down.</p>

10.5 Sensor defect alarm A5 (medium priority alarm)

<p>Control panel</p>	
<p>Alarm condition</p>	<p>At least one temperature sensor supplies a value outside the permissible range.</p>
<p>Device response</p>	<ul style="list-style-type: none"> • A5 (flashing) appears on the display (5). If both outputs are active, A5 is displayed for both outputs. • Start LED (6) and the Alarm LED (10) flash. • Acoustic alarm signal is triggered. • Heating process is interrupted at the two outputs.
<p>Possible reasons ▶ Required action(s)</p>	<p>Defective sensor(s) in the applied part. ▶ Send the applied part to the local sales point.</p> <p>Defective connection cable on the applied part. ▶ Send the applied part to the local sales point.</p> <p>Defective cable plug on the applied part. ▶ Send the applied part to the local sales point.</p> <p>Defective extension connection cable. ▶ Replace the extension connection cable.</p> <p>Defective connecting socket for output A or B on the control unit. ▶ Send the control unit to the local sales point.</p>

10.6 Heater defect alarm A6 (medium priority alarm)

<p>Control panel</p>	
<p>Alarm condition</p>	<p>The heater of the applied part is defect.</p>
<p>Device response</p>	<ul style="list-style-type: none"> • A6 (flashing) appears on the display (5). If both outputs are active, A6 is displayed for both outputs. • Start LED (6) and the Alarm LED (10) flash. • Acoustic alarm signal is triggered. • Heating process is interrupted at the two outputs.
<p>Possible reasons ▶ Required action(s)</p>	<p>Heater resistance too high or defective. ▶ Send the applied part to the local sales point.</p> <p>Defective connection cable on the applied part. ▶ Send the applied part to the local sales point.</p> <p>Defective cable plug on the applied part. ▶ Send the applied part to the local sales point.</p> <p>Defective extension connection cable. ▶ Replace the extension connection cable.</p> <p>Defective connecting socket for output A or B on the control unit. ▶ Send the control unit to the local sales point.</p>

11 Information messages and troubleshooting

11.1 Battery status (only for devices with a battery)	
Control panel	
Information condition	The battery is defect or no original battery is inserted.
Device response	After the Start screen in mains operation and in Standby mode , the display (11, 8) shows the crossed-out battery symbol.
► Required action(s)	► Insert new original battery.
	The battery should be replaced every 3 years to ensure adequate battery capacity.

11.2 Applied part temperature too low	
Control panel	
Information condition	The actual temperature (1) is lower than 20°C.
Device response	Display (1) shows L .
Possible reasons ► Required action(s)	Actual temperature is outside the display range ► Heat up the applied part.

11.3 Applied part temperature too high

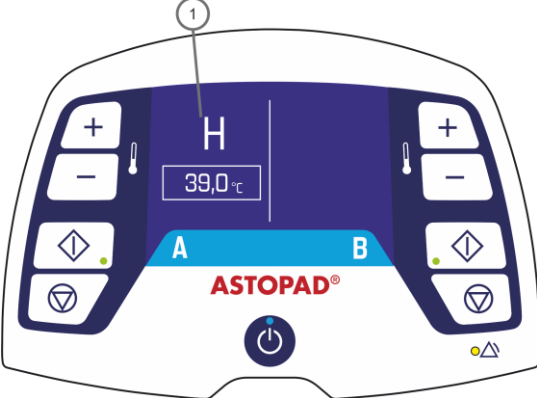



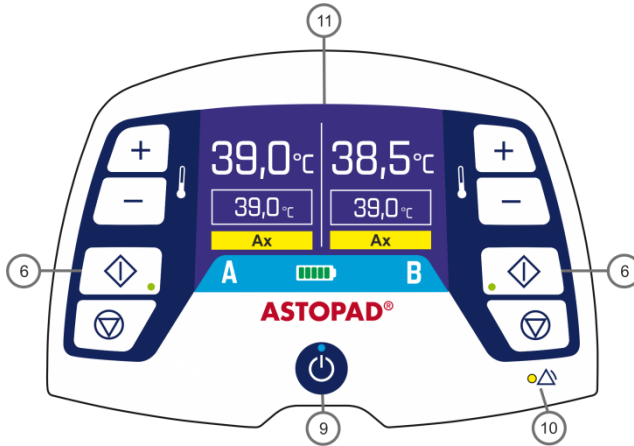



















<p>Control panel</p>	 <p>The diagram shows the ASTOPAD control panel with a central digital display showing '39,0 °C'. Above the display is a large 'H' icon, which is circled and labeled with a '1'. The panel features two sets of control buttons (plus, minus, and directional arrows) on either side of the display, and a power button at the bottom center. The brand name 'ASTOPAD®' is printed below the display.</p>
<p>Information condition</p>	<p>The actual temperature (1) is higher than 45°C.</p>
<p>Device response</p>	<p>Display (1) shows H.</p>
<p>Possible reasons ▶ Required action(s)</p>	<p>Actual temperature is outside the display range ▶ Allow the applied part to cool.</p>

12 Brief overview of operating states and alarms



12.1 Overview of operating states

Operating state	Display	Start LED	Alarm LED	Standby LED	Acous-tic alarm signal	Possible reasons
		Output A or B				
	11	Green 6	Yellow 10	Blue 9		
Standby mode		○	○	●		Standby mode
		○	○	●		Battery is being charged
		○	○	●		Battery is defective or no original battery inserted
On mode		○	○	○		Battery is defective or no original battery inserted
		○	○	○		No applied part connected
	Actual temperature Set temperature	☀	☀	○		Self-test
	L Set temperature	☀	☀	○		Self-test and actual temperature of the applied part < 20.0 °C
	H Set temperature	☀	☀	○		Self-test and actual temperature of the applied part > 45.0 °C
		○ = LED off	● = LED on	☀ = LED flashes		

Operating state	Display	Start LED Output A or B	Alarm LED	Standby LED	Acoustic alarm signal	Possible reasons
		Green 6	Yellow 10	Blue 9		
	⑪					
Heating mode	Actual temperature Set temperature 	●	○	○		Warm-up phase
	Actual temperature Set temperature A5			○		No applied part connected, or defective sensor in the applied part
	Actual temperature Set temperature A6			○		No applied part connected, or defective heating conductor in the applied part
		○	○	○		Output not started
	L Set temperature 	●	○	○		Actual temperature of the applied part < 20.0 °C
	Actual temperature Set temperature 	●	○	○		Cooling phase
	Actual temperature Set temperature 	●	○	○		Defective or incorrect battery
Mode Increase/ decrease set temperature	Actual temperature Set temperature		○	○		New set temperature not confirmed
Mode Switching off an output		○	○	○		-
	Actual temperature Set temperature			○		Only one output was started; device is in self-test
Switching off the control unit		○	○	●		See Standby mode
Off mode		○	○	○		Mains plug pulled out
Storage/ transport		○	○	○		Mains plug disconnected and Standby button was pressed for more than 3 sec. (for battery-operated equipment only)

○ = LED off

● = LED on

 = LED flashes

12.2 Overview of alarms

Alarm	Display	Start LED Output A or B	Alarm LED	Standby LED	Acous- tic alarm signal	Possible reasons
		Green 6	Yellow 10	Blue 9		
Low tempera- ture alarm A1	Actual temperature Set temperature A1					Actual temperature is at least 1°C lower than the set temperature for at least 10 minutes.
Overheating alarm A2	Actual temperature Set temperature A2					Actual temperature is at least 1°C higher than the set temperature for at least 10 minutes.
Time alarm A3	Actual temperature Set temperature A3					Set temperature not reached during 60 minutes of uninterrupted heating
Overheating alarm A4	Actual temperature Set temperature A4					Actual temperature is higher than 41°C
	H Set temperature A4					Actual temperature is higher than 45°C
Sensor defect alarm A5	Actual temperature Set temperature A5					Connection interrupted between control unit and applied part or sensor in applied part defect
Heater defect alarm A6	Actual temperature Set temperature A6					Connection interrupted between control unit and applied part or heater in applied part defect
		= LED off	= LED on	= LED flashes		

13 Maintenance

To ensure sufficient battery capacity for devices with battery option, the battery should be replaced every 3 years. Replacing the battery is described in section **13.2 Replacing the battery**.

Furthermore, ASTOPAD does not require preventative maintenance (e.g., exchange of liquids or components) but recurrent tests in accordance with section **13.1 Recurrent tests**.



ASTOPAD shall not be serviced or maintained while in use with a patient.

WARNING

Risk of injury!

- ASTOPAD may only be serviced by appropriately trained and medically qualified service personnel.
- ASTOPAD does not contain any parts the user can repair. Therefore, do not attempt to repair ASTOPAD yourself. Contact your local sales point.
- Any repairs to ASTOPAD may only be carried out by persons authorized and qualified by the manufacturer.
- Modifications to ASTOPAD are not permitted.

On request, STIHLER ELECTRONIC GmbH will provide service instructions that will allow properly trained and qualified persons to repair the parts of the device that the manufacturer has designated as repairable.

Provision of technical documents and/or spare parts is not an authorization from the manufacturer to open or repair ASTOPAD.

13.1 Recurrent tests

A recurrent test of ASTOPAD (applied part and control unit) must be performed at least every 12 months.

For the test, you can either purchase the required test device and instructions from the manufacturer or you can commission the manufacturer or your local dealer to perform the inspection of ASTOPAD.

Also, please observe all applicable national regulations (e.g., IEC 62353) on monitoring the safety of medical products and the use of calibrated testing equipment.

The inspection of the Essential Performance characteristics and all other safety-relevant functions are described in the ASTOPAD testing instructions:

- Testing instructions ASTOPAD, English (Order no. 1731.9045.12)

The following test equipment is required to carry out the repeated inspection:

- System test box for ASTOPAD (Order no. 1715.9040)



The test instructions are included in the scope of delivery of the ASTOPAD system test box.

13.2 Replacing the battery

1. Disconnect the device completely from the mains power supply (by disconnecting the mains plug)
2. Press the Standby button until the Standby LED switches off.
3. Disconnect the mains plug from the device.
4. Remove the housing cover by loosening the four housing screws (Fig. 6).
5. Remove the battery and push the new battery as far as possible (Fig. 7).
6. Mount the housing cover and secure with the four housing screws (Fig. 6).

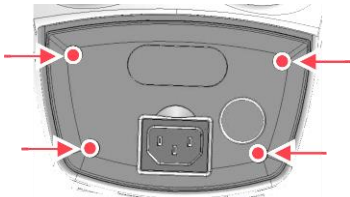

Fig. 6 Housing cover

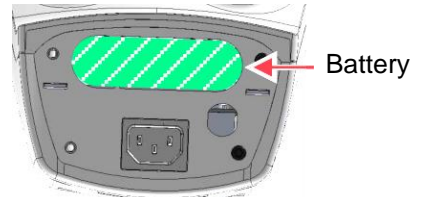

Fig. 7 Battery

14 Technical data

ASTOPAD DUO310-NA Control unit			
Electrical connection	100 – 240 VAC 50 – 60 Hz		
Rated current	110 V = 1,6 A, 240V = 0,8 A		
Primary fuses	2 x 3.15 A		
Power consumption	max. 160 W		
Classification (IEC 60529)	IPX2		
Classification (IEC 60601-1)	Protection Class I, defibrillation-protected applied part type BF		
Regulatory class as per FDA	II		
Code UMDNS	10-414(COV)		
Code GMDN	37329		
Dimensions (mm)	max.		
Height	300		
Width	155		
Depth	130		
Weight (kg)	2.0 (without battery) 2.5 (with battery)		
Operating mode	Continuous operation		
Permissible ambient conditions	Humidity	Temperature	Atmospheric pressure
In operation	10% to 75% non-condensing	+16°C to +26°C	700 hPa to 1060 hPa
During storage/transport		-20°C to +50°C	

ASTOPAD DUO310-NA Control unit	
Control of contact surface temperature (Essential Performance according to IEC 80601-2-35)	32.0 °C to 39.0 °C in 0.5 °C increments Tolerance ± 1.0 °C
Contact surface temperature display precision	± 0.7 °C
Overheating shut-off	41.0 °C (± 0.5 °C)
Acoustic alarm volume level (distance = 1 m)	Approx. 60 dB(A)
Service Life	The expected service life is 60 months from the date of first use provided the product is not subject to misuse, negligence, accident or abuse and under the conditions that the device is properly used and maintained as intended.

ASTOPAD All applied parts			
Electrical connection	24 VDC		
Classification (IEC 60529)	IPX2		
Permissible ambient conditions	Humidity	Temperature	Atmospheric pressure
In operation	10% to 75% non-condensing	+16°C to +26°C	700 hPa to 1060 hPa
During storage/transport		-20°C to +50°C	
Time to heat from 23.0 °C to 37.0 °C	Approx. 10 minutes		
Service Life	The expected service life is 30 months from the date of first use provided the product is not subject to misuse, negligence, accident or abuse and under the conditions that the device is properly used and maintained as intended.		

ASTOPAD	COV 070-NA	COV 105-NA	COV 150-NA	COV 155-NA	COV 180-NA
Power consumption	60 W	115 W	150 W	85 W	150 W
Dimensions (mm)	approx.	approx.	approx.	approx.	approx.
Length	680	1050	1500	1500	1800
Width	480	500	500	500	800
Height	30	30	30	30	30
Weight (kg)	0.7	1.1	1.4	1.3	2.2
Connection cable	Approx. 50-cm PVC cable				
Extension connection cable	2 m				
ASTOPAD	Built-in, rechargeable battery for ASTOPAD DUO310-NA control unit (optional)				
Type	Li-Ion				
Energy level	99.4 Wh				
Dimensions (mm) Length x Width x Height	150 x 77 x 22				
Weight	430 g				

NOTICE

The specified defibrillation protection is ensured only when the applied part is connected to the control unit.



Explosion hazard!

Do not use the ASTOPAD patient warming system in an explosion-hazard environment or in the presence of flammable anesthetics.

15 Conformity with international standards

Standard	Title
IEC 60601-1 ANSI/AAMI ES 60601-1 CAN/CSA C22.2 No. 60601-1	Medical electrical equipment – Part 1: General requirements for basic safety, including essential performance
IEC 60601-1-2	Medical electrical equipment – Part 1-2: General requirements for basic safety, including essential performance – Supplementary standard: Electromagnetic compatibility – Requirements and tests
IEC 60601-1-6	Medical electrical equipment - Part 1-6: General requirements for basic safety and essential performance - Collateral Standard: Usability
IEC 60601-1-8	Medical electrical equipment – Part 1-8: General requirements for basic safety, including essential performance – Supplementary standard: Alarm systems – General requirements, tests, and guidance for alarm systems in medical electrical equipment and medical electrical systems
IEC 80601-2-35	Medical electrical equipment Part - 2-35: Particular requirements for basic safety and essential performance of heating devices using blankets, pads, or mattresses and intended for heating in medical use

Definitions according to IEC 80601-2-35:

Term	Definition	ASTOPAD applied parts
Over-blanket	Blanket designed to be used over a patient	COV155-NA
		COV070-NA COV105-NA
Under-blanket	Blanket designed to be used under a patient	COV150-NA COV180-NA

16 Ordering information and Accessories

Ref.	Description
Control unit compatible with ASTOPAD COV applied parts	
DUO310-NA	ASTOPAD DUO310 control unit, 100-240 VAC, 50-60 Hz, Hospital Grade plug
1831.0001	Rechargeable battery for ASTOPAD DUO310 control unit (optional)
Applied parts (incl. standard extension connection cable COV50200)	
COV070-NA	ASTOPAD COV070 warming blanket 680 x 480 mm
COV105-NA	ASTOPAD COV105 warming blanket 1050 x 500 mm
COV150-NA	ASTOPAD COV150 warming blanket 1500 x 500 mm
COV155-NA	ASTOPAD COV155 Arm-chest-warming blanket 1500 x 500 mm (with cut-outs)
COV180-NA	ASTOPAD COV180 warming blanket 1800 x 800 mm
Accessories	
COV50200	Standard extension connection cable, 2.0 m

We reserve the right to modify design and technical data without notice.

17 Guidelines and manufacturer's declaration

Guidance and manufacturer's declaration - electromagnetic emissions		
ASTOPAD is intended for use in the electromagnetic environment specified below. The customer or user of the ASTOPAD should assure that it is used in such an environment.		
Emision test	Compliance	Electromagnetic environment - guidance
RF emissions CISPR 11/EN 55011	Group 1	ASTOPAD uses RF energy only for its internal function. Therefore, its RF emissions are very low and are not likely to cause interference in nearby electronic equipment.
RF emissions CISPR 11/EN 55011	Class A	The EMISSIONS characteristics of this equipment make it suitable for use in industrial areas and hospitals (CISPR 11 class A). If it is used in a residential environment (for which CISPR 11 class B is normally required) this equipment might not offer adequate protection to radio-frequency communication services. The user might need to take mitigation measures, such as relocating or re-orienting the equipment.
Harmonic emissions IEC/EN 61000-3-2	Class A	
Voltage fluctuations / flicker emissions IEC/EN 61000-3-3	Complies	

Guidance and manufacturer's declaration - electromagnetic immunity			
The ASTOPAD is intended for use in the electromagnetic environment specified below. The customer or user of the ASTOPAD should assure that it is used in such an environment.			
Immunity test	Test level	Compliance level	Electromagnetic environment - guidance
Electrostatic discharge (ESD) IEC/EN 61000-4-2	± 8 kV contact ± 2 kV, ± 4 kV, ± 8 kV, ± 15 kV air	in compliance	Floors should be wood, concrete or ceramic tile. If floors are covered with synthetic material, the relative humidity should be at least 30%.
Electrical fast transient/bursts IEC/EN 61000-4-4	± 2 kV 100 kHz repetition frequency	in compliance	Mains power quality should be that of a typical commercial or hospital environment.
Surge IEC/EN 61000-4-5	± 0.5 kV, ± 1 kV Line-to-line ± 0.5 kV, ± 1 kV, ± 2 kV Line- to-ground	in compliance	Mains power quality should be that of a typical commercial or hospital environment.
Voltage dips-IEC/EN 61000-4-11	0 % U _r ; 0.5 cycle At 0°, 45°, 90°, 135°, 180°, 225°, 270° and 315°	in compliance	Mains power quality should be that of a typical commercial or hospital environment. If the user of the ASTOPAD requires continued operation during power mains interruptions, it is recommended that the ASTOPAD be powered from an uninterruptible power supply or a battery.
	0 % U _r ; 1 cycle and 70 % U _r ; 25/30 cycles Single phase: at 0°		
Voltage interruptions IEC/EN 61000-4-11	0 % U _r ; 250/300 cycle	in compliance	
Rated power frequency magnetic fields IEC/EN 61000-4-8	30 A/m 50 Hz or 60 Hz	in compliance	Power frequency magnetic fields should be at levels characteristic of a typical commercial or hospital environment.
NOTE U _r is the AC mains voltage prior to application of the test level.			

Guidance and manufacturer's declaration - electromagnetic immunity			
The ASTOPAD is intended for use in the electromagnetic environment specified below. The customer or user of the ASTOPAD should assure that it is used in such an environment.			
Immunity test	Test level	Compliance level	Electromagnetic environment – guidance Recommended separation distance
Conducted disturbances induced by RF fields IEC/EN 61000-4-6	3 Vrms 0.15 MHz to 80 MHz	in compliance	$d = 1.2\sqrt{P}$
	6 Vrms in ISM bands between 0.15 MHz and 80 MHz		
	80 % AM at 1 kHz		
Radiated RF EM fields IEC/EN 61000-4-3	3 V/m / 10 V/m 80 MHz to 2.7 GHz	in compliance	$d = 1.2\sqrt{P}$ 80 MHz to 800 MHz
	80 % AM at 1 kHz		$d = 2.3\sqrt{P}$ 800 MHz to 2.7 GHz
	Portable and mobile RF communications equipment should be used no closer to any part of the ASTOPAD, including cables, than the recommended separation distance calculated from the equation applicable to frequency of the transmitter.		
Where P is the maximum output power rating of the transmitter in watts (W) according to the transmitter manufacturer and "d" is the recommended separation distance in meters (m). Field strengths from fixed RF transmitters, as determined by an electromagnetic site survey, ^a should be less than the compliance level in each frequency range ^b . Interference may occur in the vicinity of equipment marked with the following symbol:			
			
NOTE1. At 80 MHz and 800 MHz, the higher frequency range applies. NOTE2. These guidelines may not apply in all situations. Electromagnetic propagation is affected by absorption and reflection from structures, objects and people.			
^a Field strengths from fixed transmitters, such as base stations for radio (cellular/cordless) telephones and land mobile radios, amateur radio, AM and FM radio broadcast and TV broadcast cannot be predicted theoretically with accuracy. To assess the electromagnetic environment due to fixed RF transmitters, an electromagnetic site survey should be considered. If the measured field strength in the location in which the ASTOPAD is used exceeds the applicable RF compliance level above, the ASTOPAD should be observed to verify normal operation. If abnormal performance is observed, additional measures may be necessary, such as reorienting or relocating the ASTOPAD.			
^b Over the frequency range 150 kHz to 80 MHz, field strength should be less than 3 V/m.			

Recommended separation distances between Portable and mobile RF communications equipment and the ASTOPAD			
The ASTOPAD is intended for use in the electromagnetic environment in which radiated RF disturbances are controlled. The customer or user of the ASTOPAD can help prevent electromagnetic interference by maintaining a minimum distance between portable and mobile RF communications equipment (transmitters) and the ASTOPAD as recommended below, according to the maximum output power of the communications equipment.			
Rated maximum output power of transmitter (W)	Separation distance according to frequency of transmitter (m)		
	150 kHz to 80 MHz $d = 1.2\sqrt{P}$	80 MHz to 800 MHz $d = 1.2\sqrt{P}$	800 MHz to 2.7 GHz $d = 2.3\sqrt{P}$
0.01	0.12	0.12	0.23
0.1	0.38	0.38	0.73
1	1.2	1.2	2.3
10	3.8	3.8	7.3
100	12	12	23
For transmitters rated at maximum output power not listed above, the recommended separation distance d in meters (m) can be estimated using the equation applicable to the frequency of the transmitter, where P is the maximum output power rating of the transmitter in Watts (W) according to the transmitter manufacturer. NOTE 1: The compliance level between 80 MHz and 2.7 GHz is intended to decrease the likelihood that mobile/portable communication equipment could cause interference if it is inadvertently brought into patient areas. For this reason, an additional factor of 10/3 is used in calculating the recommended separation distance for transmitters in this frequency range.			
NOTE 2: These guidelines may not apply in all situations. Electromagnetic propagation is affected by absorption and reflection from structures, objects and people.			

